

ComBi *line*

CB 5

CB 10

CB 20

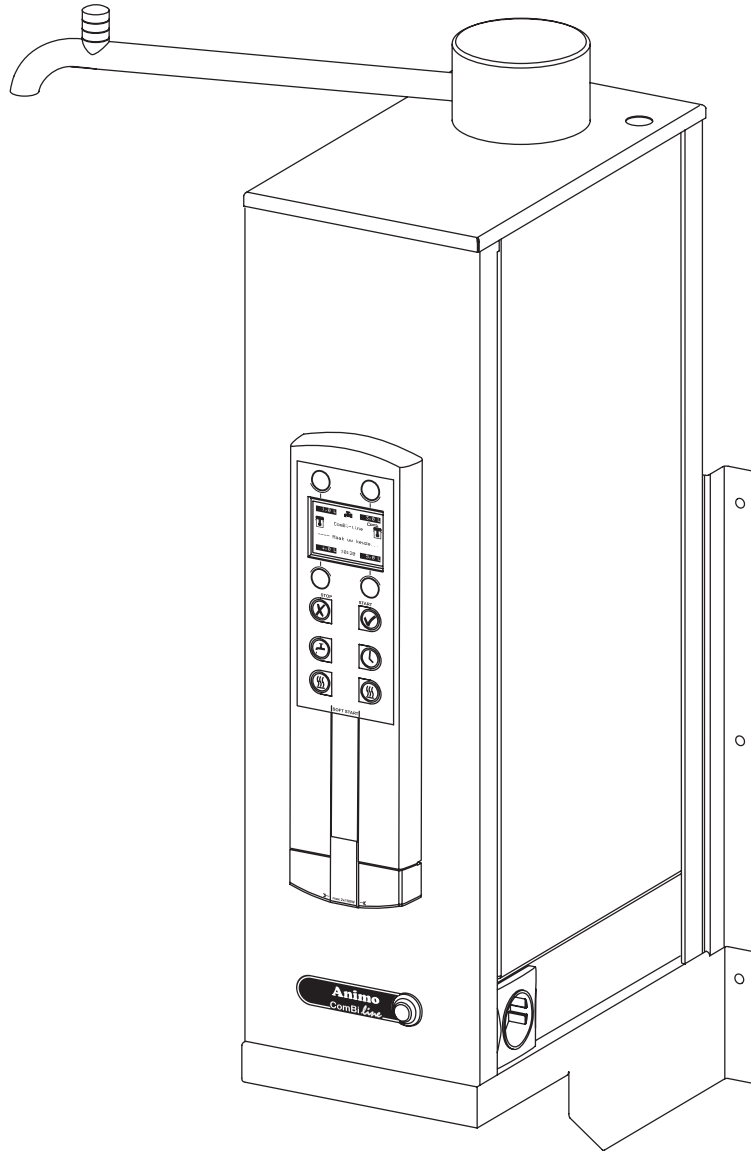

Ⓝ NL Gebruiksaanwijzing

Ⓝ GB Manual

Ⓝ D Betriebsanleitung

Ⓝ F Mode d'emploi

Animo

Nederlands

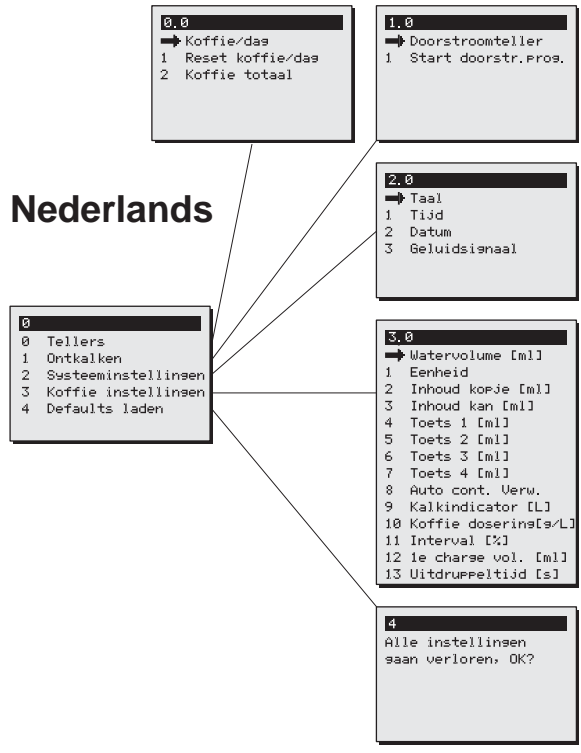

English

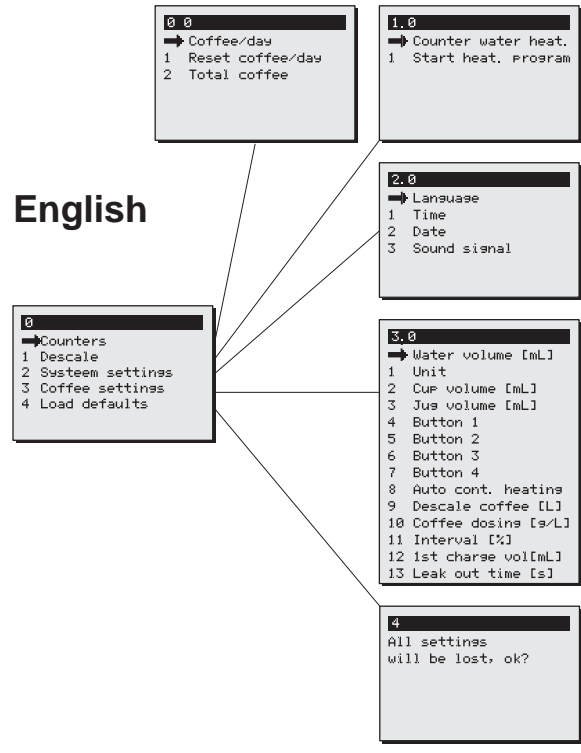

Deutsch

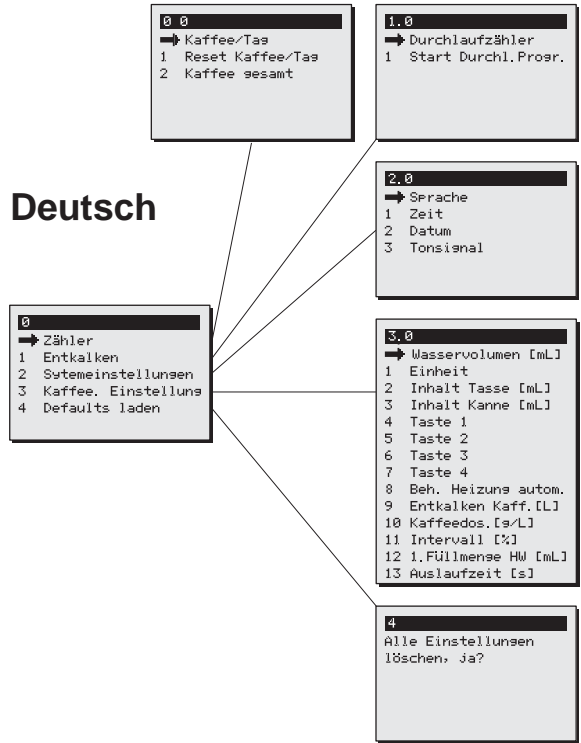

Français

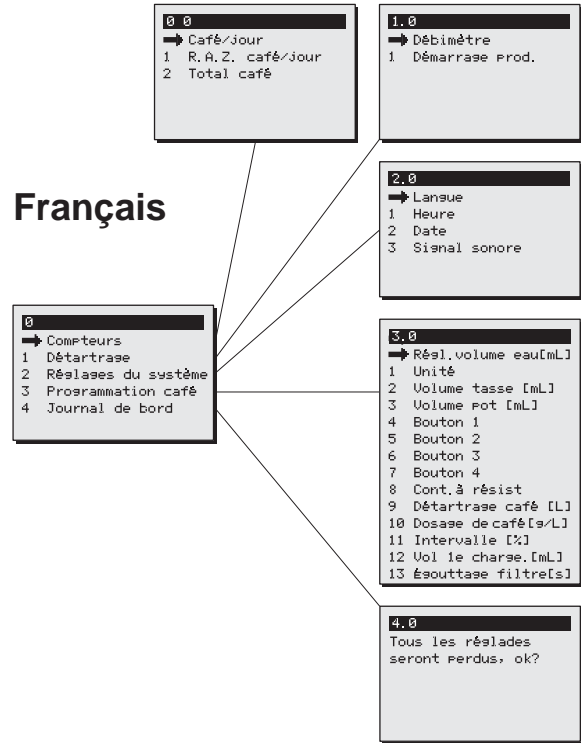

Code nr	PIN code/Geheimzahl	Code nr	PIN code/Geheimzahl
1	4 2 1 2 2	11	4 2 3 2 2
2	3 3 4 4 3	12	4 3 2 2 2
3	1 4 1 1 3	13	3 2 2 4 4
4	2 4 2 1 2	14	3 3 1 2 4
5	3 3 3 1 3	15	3 4 3 1 2
6	1 4 4 4 1	16	3 4 4 2 4
7	4 1 2 3 1	17	1 4 2 2 4
8	3 4 3 1 4	18	1 3 2 4 4
9	4 2 1 3 4	19	3 3 4 4 1
10	3 3 3 1 4	20	1 4 1 3 4

ComBi-line Wandmodel
ComBi-line Wall model
ComBi-line Wandmodell

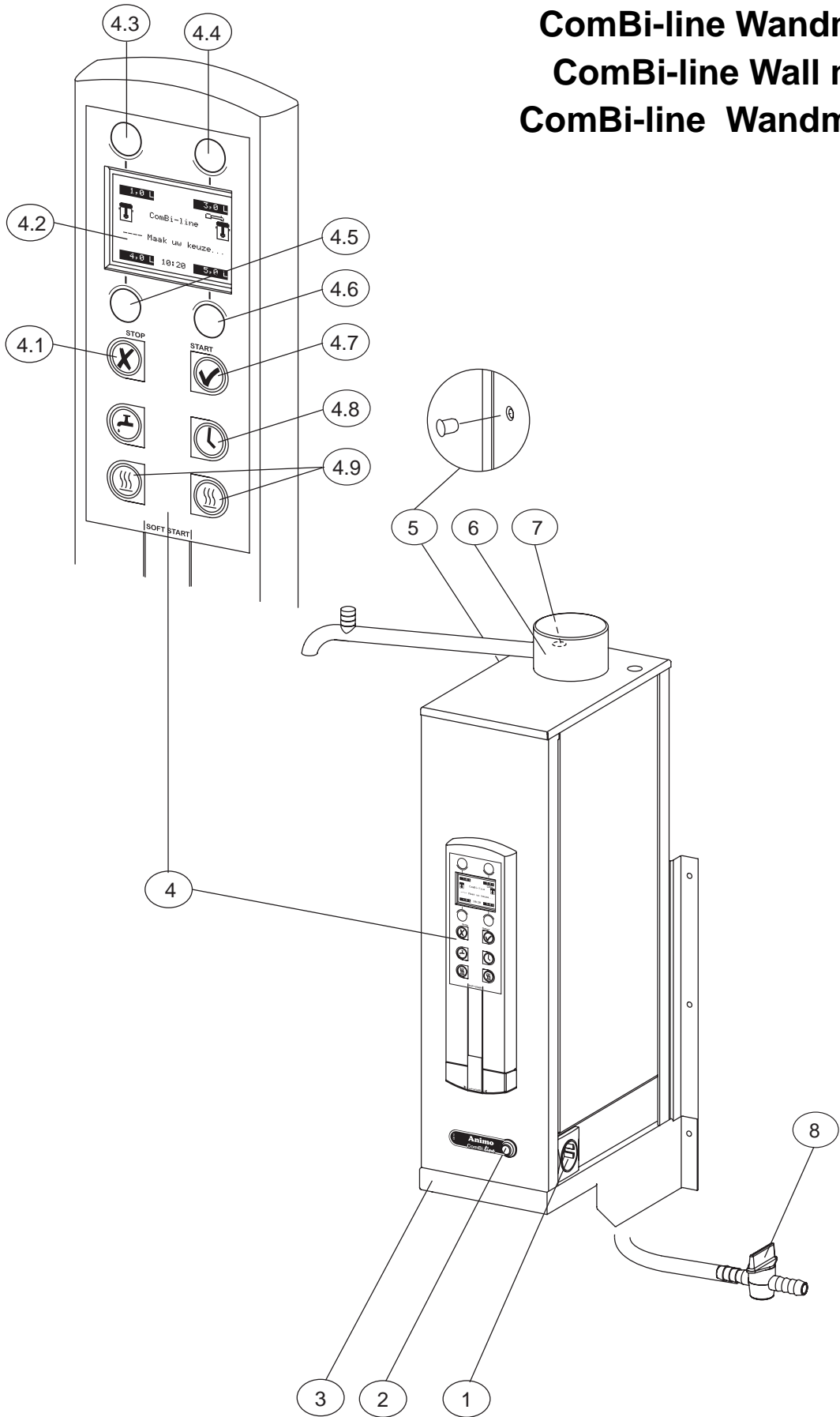
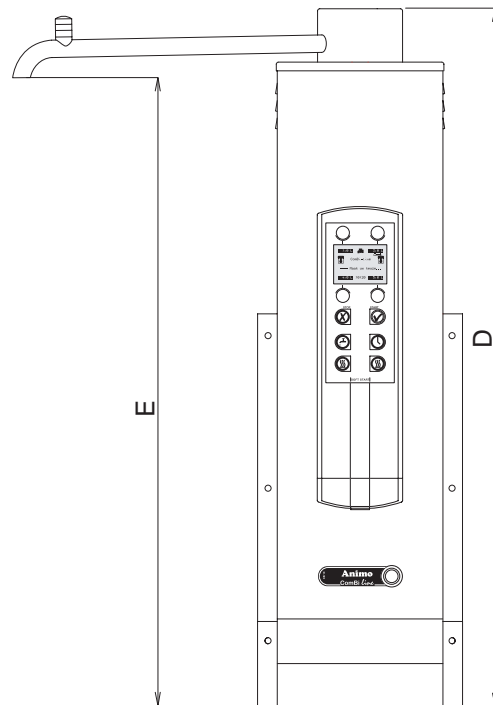
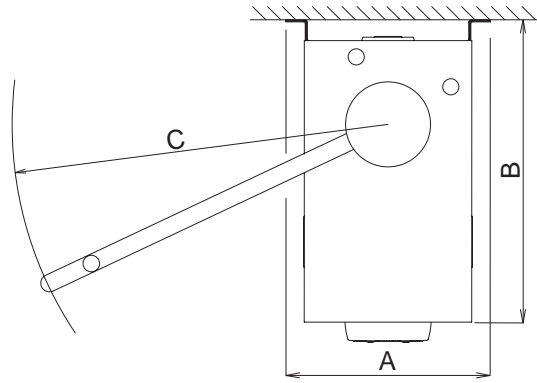

Fig. 1/ Abb. 1



Afmetingen / Dimensions / Maße ComBi-line			
	CB 5	CB 10	CB 20
A =	235	235	235
B =	345	345	345
C =	430	430	430
D =	707	800	901
E =	631	723	825
F =	146	146	146
G =	102	102	102
H =	67	67	67
I =	54	54	54
J =	49	49	49

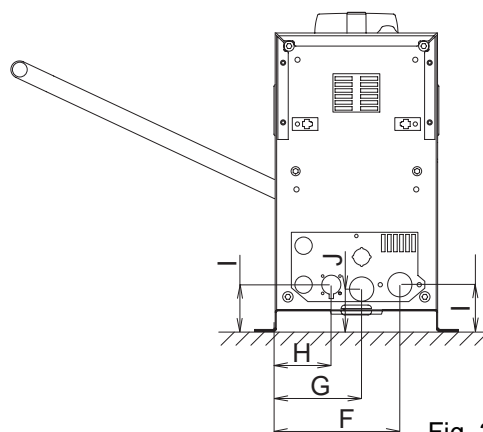

Fig. 2/ Abb. 2

Nederlands	1
English	41
Deutsch	81
Français	121

TABLE OF CONTENTS

	Preface	42
	Introduction	43
	Safety instructions and danger warnings	44
	Safeguards	45
	Appliance and the environment	45
1.	GENERAL	46
	1.1 A quick look at the appliance	46
	1.1.1 Most important parts (fig. 1)	46
2.	TECHNICAL DETAILS	47
3.	INSTALLATION	49
	3.1 Unpacking	49
	3.2 Preparation for positioning	49
	3.3 Water connection	50
	3.3.1 Water treatment	50
	3.4 Water drainage	50
	3.5 Electrical connection	50
	3.6 Mounting the DWI on a wall	51
4.	FIRST TIME USE	52
	4.1 Flushing the flow water system	52
	4.2 First settings operator menu	52
5.	OPERATING PANEL	53
	5.1 Overview control panel buttons	53
	5.2 Overview display symbols	54
	5.3 Overview error reporting symbols	55
6.	DAILY USE	56
	6.1 Brewing coffee	57
	6.1.1 Brewing tea	58
	6.1.2 Timer function	59
7.	MAINTANANCE	60
	7.1 Cleaning	60
	7.1.1 Cleaning general	60
	7.1.2 Cleaning daily	60
	7.1.3 Cleaning weekly	61
	7.1.4 Cleaning the tap	61
	7.1.5 Cleaning the gauge glass	62
	7.2 Periodic descaling activities	63
	7.2.1 Descaling the coffee maker	63
8.	TEMPERATURE PROTECTION	63
9.	TRANSPORT	63
10.	CONSUMER ARTICLES AND ACCESSORIES	64
11.	TABLE OF CONTENTS OPERATOR MENU	65

© 2004 Animo®

All rights reserved.

No part of this document may be reproduced and/or published by means of printing, microfilm, electronic or any other means whatsoever without the prior written permission of the manufacturer. This also applies to the accompanying drawings and/or diagrams.

Animo reserves the right to change parts at any time without giving prior or direct notification to the customer. The content of this manual can also be changed without prior notification.

This manual covers the standard model of the appliance. Animo can therefore not be held liable for any losses arising from the fact that the specifications of the appliance supplied to you deviate from the standard model. Please contact your supplier's service department for information concerning adjustment, maintenance or repairs not covered by this manual.

Although this manual was produced with the greatest possible care, the manufacturer is unable to accept liability for errors in this document or their consequences.

You are advised to carefully read the instructions in this document: they contain important information about safety when installing, using and maintaining the appliance. Keep this document in a safe place so that you can consult it when necessary.

PREFACE

Purpose of this document

This document serves as a manual that enables qualified personnel to safely install, program and maintain the appliance. This document contains information for two sorts of users:

- By **partly qualified personnel** we mean: someone who uses the appliance daily and carries out the daily maintenance.
- By **trained, qualified personnel** we mean: someone who can change the settings in the operator menu (reachable via a PIN), carry out maintenance and resolve small faults.

All of the chapters and paragraphs are numbered. The various illustrations to which the text refers are given in the fold-out sheets or at the back of this booklet or under the particular subjects.

Icons and symbols



NOTICE

General instructions for: IMPORTANT, NOTE or REMARK.



CAUTION !

Warning of possible damage to the appliance, the surroundings or the environment.



WARNING

Warning of possible serious damage to the appliance or physical injury.



WARNING

Warning of electricity hazard.

Introduction

Congratulations on your purchase of one of our products. We hope that you will enjoy using it.

Models

This manual covers the following coffeemakers of the ComBi-line range:

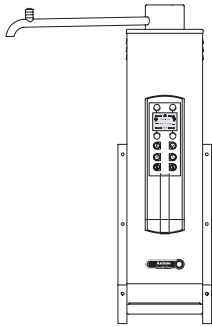

CB 5/10/20

Purpose of the appliance

This machine can only be used for brewing and distributing coffee and/or tea.

The use of the appliance for other purposes is not permitted and may be hazardous.

The manufacturer cannot be held liable for losses caused by using the appliance for purposes other than those indicated here or by incorrect use.

Service and technical support

Please contact your dealer for information not given in this document regarding specific adjustment, maintenance and repairs. Before contacting your dealer you should note the following appliance details, marked with a #. You will find these details on the type plate attached to your appliance.

- A - Type #
- B - Article number #
- C - Machine number #
- D - Supply voltage
- E - Frequency
- F - Output

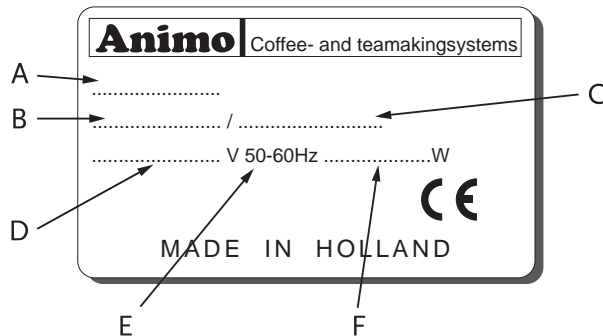

Guarantee conditions

The guarantee conditions applicable to this appliance form an integral part of the general terms of delivery.

Directives

This appliance meets the requirements of the EMC Directive 89/336/EEC, the Low Voltage Directive 72/23/EEC, and the machine directive 98/37/EEG.

Safety instructions and danger warnings

This appliance meets the mandatory safety regulations. Inexpert use can result in personal injury and material damage. The following warnings and safety instructions must be observed before using the coffee maker.

Instructions for use

Read these instructions for use carefully, before using this appliance. This will protect your safety and prevent damage being caused to the appliance. Perform the various actions in the order given. Always keep this manual close by the appliance.

Installation

- Place the appliance at buffet height and on a firm, level base, in such a way that it can be connected to the water supply and power supply.
- Connect the appliance to an earthed wall socket.
- Position the appliance in such a way that no damage can be caused if it leaks.
- Do not tilt the appliance, always position and move the appliance upright.
- Connect an overflow pipe to the drainage tube.
- Water always remains in the heating system: for this reason the appliance must not be placed in an area where the temperature can fall below freezing point.
- When installing the appliance, always observe the local rules and use approved materials and parts.
- The Installation chapter must again be followed when repositioning the appliance.
- Connect the appliance to the cold water mains.

Use

- Inspect the appliance before using it and check it for damage.
- Never submerge or spray the appliance.
- Do not press the buttons with a sharp object.
- Protect the controls against dirt and grease.
- During use some parts will become very hot.
- Do not position the container on open fire, or hot plate.
- First disconnect the electric cable before transporting the container.
- It is advisable to take the plug out of the socket and close the water tap if the appliance is not going to be used for longer periods of time

Maintenance and troubleshooting

- Observe the descaling intervals indicated by the descaling indicator symbol.
- Overdue maintenance to the heating system can result in high repair costs and annulment of the guarantee.
- Do not leave the appliance unattended when maintenance is being performed.
- When descaling the appliance, it is advisable to wear safety glasses and protective gloves.
- Wash your hands after descaling.
- Have all repairs carried out by a qualified technician.
- The plug must be taken out of the socket if the appliance has to be opened for cleaning or repairs.

The manufacturer cannot be held liable for losses caused as a result of failure to observe these safety instructions.

Safeguards

The appliance is fitted with the following safeguards:

On/off switch (fig. 1-2)

The on/off switch is used to switch the appliance on and off. Remember that the appliance can still be live after being switched off! For this reason you should always remove the plug from the socket to render the appliance voltage-free.

STOP button (fig. 1-4.1)

The coffee making process can be interrupted at any point using the STOP button located on the control panel.

Swivel arm and container detection

This appliance is equipped with a safety device through which it is only possible to start the brewing process if the swivel arm and container are in the correct position. If the swivel arm and/or container are moved out of position during the brewing process, the brewing process is interrupted, a swivel arm and/or container symbol appears in the display and there is a sound signal (2x short). Once the positioning fault has been resolved the brewing process can be restored by pressing the START button.

Dry-boil protection

This appliance is equipped with a dry-boil protection. This protection triggers if the heating elements overheat owing to a fault. Once the fault has been resolved, the dry-boil protection can be reset at the outside of the appliance. The most common cause of the dry-boil protection being triggered is not descaling the heating system in time.

Warning indication display

A technical fault is reported by displaying an error code in the display. The relevant problem can be localised and resolved with the help of this code. In this case see chapter 13-TROUBLESHOOTING.

Appliances and the environment

The packing material

Your new coffee maker has been carefully packaged to protect it against damage.

The packing is not harmful to the environment and consists of the following materials:

- Corrugated cardboard.
- Filler elements made of polyurethane foam <PUR> covered with a polythene film (>PE-HD<).

The waste processing plant in your municipality will be pleased to inform you where you can dispose of the materials.

Discarding the appliance

No appliance lasts forever. When the time comes to discard your appliance it will usually be possible to return it to your dealer. If this is not the case, ask your municipal council about the alternatives for recycling the materials. All plastic parts have been given standard codes. The parts of the appliance such as the printed circuit board and accompanying parts form electrical and electronic waste. The metal body is made of stainless steel and can be completely dismantled.

1. GENERAL

The ComBi-line 5 - 20 is a professional coffee maker, equipped with a continuous flow heater. The appliance comes with a separate hot water system with a no-drip tap through which it is possible to draw off hot water during the coffee brewing process. This hot water system can be used for the making of tea, hot chocolate, instant soup etc. It is very easy to use. The user can choose from a number of fixed set amounts via a control panel with a graphic display which also offers information about the current process of the appliance. Specific requirements and wishes concerning brewing quantity, hot water temperature, etc. can be accessed and programmed by the operator via a PIN. The operator also has the possibility of reading counters and activating a descaling program.

1.1 A quick look at the appliance

The most important parts of the appliance are shown in the fold-out sheet in this manual. Keep the fold-out sheet open when reading the instructions.

1.1.1 Most important parts (fig. 1)

1. Socket L/R for container heating
2. ON/OFF switch coffee brewing system
3. Wall bracket
4. Control panel
 - 4.1 STOP button / Back button (without changing)
 - 4.2 Illuminated display
 - 4.3 Selection button brew volume 1
 - 4.4 Selection button brew volume 2
 - 4.5 Selection button brew volume 3
 - 4.6 Selection button brew volume 4
 - 4.7 START button / Accept button (save)
 - 4.8 Timer button
 - 4.9 On/Off button container heating L/R
5. Dry-boil protection coffee brewing system
6. Swivel arm
7. Descale filling opening coffee brewing system
8. Drain hose coffee brewing system

2. TECHNICAL DETAILS

Model	CB 5	CB 10	CB 20
Article number	10630	10670	10710
Capacity coffee system			
Brew time (water dosing time)	approx. 10 min./5 liter	approx. 10 min./10 liter	approx. 14 min./ 20 liter
Hour capacity (water volume)	30 liter	60 liter	90 liter
Containers			
Model	CN5e	CN10e	CN20e
Filter paper	Ø101/317	Ø152/457	Ø203/533
Contents	5 liter	10 liter	20 liter
Electrical system			
Electrical connection	3N~ 380-415V	3N~ 380-415V	3N~ 380-415V
Frequency	50-60 Cy	50-60 Cy	50-60 Cy
Power	5400W	8400W	11400W
Dimensions and weights			
Dimensions	See fig. 2	See fig. 2	See fig. 2
Weight empty	17 kg	20 kg	23 kg
Weight filled	21 kg	26 kg	29 kg
Water system			
Water hardness	min. 5°dH (min. 9°fH, 0,9 mmol/l)		
Water resistance	≥ 15 µ Siemens/cm		
Water connection	swivel 3/4" outer tread		
Min. water pressure	0,02 MPa (0,2 bar)		
Max. water pressure	1 MPa (10 bar)		
Flow pressure	5 l. / min.		
Overflow connection	tube Ø 25 mm		

Technical modifications reserved.

Surrounding conditions

Water always remains in the heating system: for this reason the appliance must not be placed in an area where the temperature can fall below freezing point. The working of this appliance is guaranteed upto a surrounding temperature of 40°C.

Recommended maintenance products

Descaler: Animo scale remover.

Cleaner: Animo coffee fur remover.

See chapter 10 for information on how to order the maintenance products.

Recommended coffee and basket filter paper

The best results are achieved by using standard ground coffee. After selecting brewing quantity, the display will advise you how much coffee should be put in the filter. This recommended amount can be set completely according to your preference through the operator menu, see chapter 12.4.8.

Only use the supplied Animo basket filter paper or filter paper of the same measurements and quality.

See chapter 10 for information on how to order usable parts.

3. INSTALLATION

This appliance may only be positioned and connected by a qualified service engineer.
The following rules must be observed:

- only suitable for indoor use
- not suitable for use in humid areas
- not suitable for areas with explosion hazard

3.1 Unpacking

The machine has been carefully packed to prevent damage being caused to your new appliance.
Remove the packing carefully without using sharp objects. Check if the appliance is complete.
The appliance (column) will be delivered already mounted on a console according to specifications below.

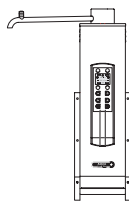

Model

CB 5/10/ 20

Carton with accessories column:

1

- 1 wall bracket
- 1 connection hose 1,5m
- 1 descaling funnel
- 1 sachet coffee fur remover
- 1 sachet scale remover
- 1 swivel arm
- 1 manual

Please contact your dealer in case parts are missing or damaged.

WARNING



- Water always remains in the heating system: for this reason the appliance must not be placed in an area where the temperature can fall below freezing point.
-

3.2 Preparation for positioning

- Place the appliance at buffet height on a firm, level base that can withstand the weight of the machine when filled.
- Make sure that the appliance is level and placed somewhere where it will not cause damage should leakage occur.
- Place the appliance in such a way that the descaler filling opening on the top of the column can be reached.
- The water supply line (G3/4" 15 mm pipe), a discharge for the overflow connection (25 mm hose) and the power connection must be within half a meter of where the machine is positioned.
- The user is responsible for ensuring that these technical installation preparations are executed according to local regulations by qualified engineers.
- The service engineer is only permitted to connect the appliance to the prepared connection points.

3.3 Water connection

Connect the appliance using the water hose to an easily accessible aeration tap that can be closed quickly if problems arise. The minimum water pressure may not be under 0,2 Bar (at 5L/min. flow pressure)



The appliance can only be connected to a cold water outlet.

3.3.1 Water treatment

You are emphatically advised to use a water softener and/or a water filter if the water contains too much chlorine or is too hard (>8°dH). This enhances the quality of the drink and precludes having to descale the appliance too often.

3.4 Water drainage

Connect the overflow connection to the open connection with a drain (syphon) in such a way that the excess water can be drained in case of a malfunction or maintenance.

3.5 Electrical connection

WARNING

- Supply voltages and frequencies can differ between countries. Check if the appliance is suitable for connection to the local power mains. Check if the details on the type plate correspond.

The earthed wall socket and the fused group with a main switch belong to the electrical installation. No heavy machines that could cause variations in power when being switched on, can be connected to this group. A machine with power current (three phase) is delivered from the factory without plug. At delivery, the machine must be provided with an electrically suitable plug as advised and provided by the installer.

- (fig. 3) In case of 3N~ 400V (5-core cable).
- (fig. 4) In case of 3~ 230V (4-core cable).
- (fig. 5) In case of 1N~ 230V (3-core cable).

The following points should be observed when wiring a new plug:

- The green/yellow-coloured wire ("EARTH") should be connected to the terminal which is either marked with the letter "E", the "earth" symbol (\perp), or coloured green or green/yellow.
- The blue-coloured wire ("NEUTRAL") should be connected to the terminal which is either marked with the letter "N" or coloured black.
- The brown-coloured wire ("PHASE") should be connected to the terminal which is either marked with the letter "L1, L2 and L3" or coloured red.

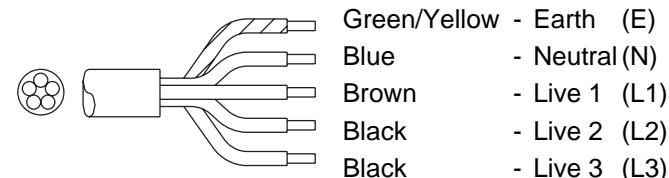

fig. 3

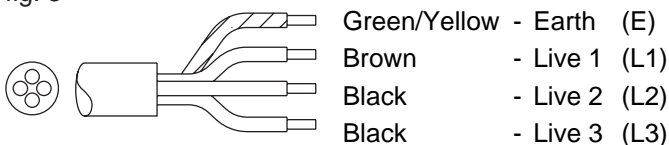

fig. 4

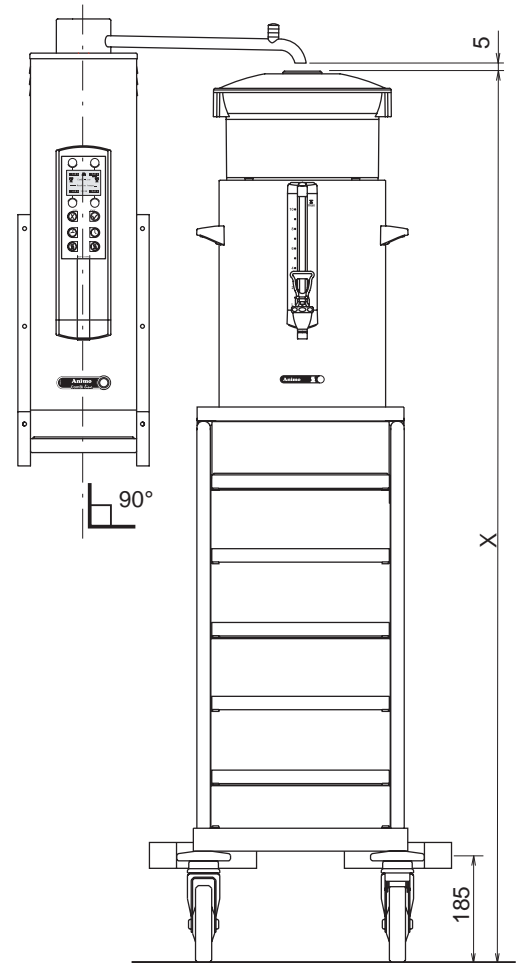

fig. 5

3.6 Mounting the DWI on a wall

Mount the appliance on the wall with the aid of the bracket supplied in accordance with the condition of the mounting wall and with the aid of suitable plugs. In case of cellular concrete, plasterboard or similar walls of other materials screw right through them or apply extra wall reinforcement.

1. The local voltage should correspond to the specifications indicated on the type plate.
2. Determine the complete arrangement of the serving trolley(s) with flow water heaters.
3. Determine position of the flow water heater, see the figure alongside.
4. Mount the flow water heater to the wall with the aid of the bracket supplied and connect electricity, water supply and overflow pipe.
5. Position the serving trolley, container and filter next to the flow water heater (take the parking rails into account see point 6), adjust the stop of the swivel arm in such a way that the outlet is always above the centre of the filter. The stop can be reached by pulling the swivel arm up vertically.
6. Take note! the swivel arm should always be at a slight downward angle.
7. Determine the place of the parking rails and mount them on the wall at the correct height in such a way that the serving trolley will stand with its round push rubbers in between the parking rails.
8. Attach the drip tray to the to the bracket with the aid of the supplied side strips.



CB with serving trolley



NOTICE

If only one serving trolley is placed next to the flow water heater, we recommend you to adapt the swivel arm protection (located under the swivel arm) on the side on which no serving trolley is placed. This prevents the possibility of starting the flow water heater when the swivel arm is in the opposite direction to the one where the serving trolley is placed. The adaptation is done as follows.

1. Remove the swivel arm by lifting it vertically out of the flow water heater.
2. Detach the relevant stop from the swivel arm bottom.
3. Remove the magnet from the underside of this stop.
4. Reassemble the stop on the bottom.
5. Place the swivel arm back on the flow water heater.
6. Test whether the flow water heater can only be activated when it is above the filter.



The supplier cannot be held liable for any consequences arising from failure during installation of the appliance according to the instructions.

4. FIRST TIME USE

The instructions given in chapter 3-INSTALLATION must be carried out before the new appliance can be put into operation. This appliance may only be used in combination with the supplied coffee container(s) and synthetic filter(s).

- When used for the first time the appliance works according to the standard factory settings. The various settings can be altered by trained, authorized personnel. See chapter 11-OPERATOR MENU.
- This chapter will explain the coffee brewing system process:
when the appliance is used for the first time.
when the appliance has not been used for more than 1 week, for example after a holiday period.

4.1 Flushing the flow heater system

1. Open the water tap and check if the swivel connections are not leaking.
2. Put the cable with inlet plug into the back of the container and insert the plug into the socket of the flow water heater (fig. 1-1).
3. Check if the containers are positioned correctly, with a filter unit (still without coffee), and position the swivel arm above the centre of the filter.
4. Switch the appliance on by putting the ON/OFF switch (fig. 1-2) in position I, the display (fig. 1-4.2) lights up and you will hear a beeping sound. Then the display will indicate the standard choices.
5. Press selection button 2 (fig. 1-4.4) and confirm your choice by pressing the START button (fig. 1-4.7). The coffee system starts filling and the brewing process starts. In the display appears the text: **BREWING**. With the STOP button (fig.1-4.1) the brewing process can be interrupted at any moment. When the water supply stops coming out of the swivel arm, you will hear a beeping sound (1x short). In the display appears the text: **LEAKING**. The leaking time is set as standard to approx. 5 minutes, and its ending is indicated by a beeping sound (3x short).
6. Empty the container with the drainage tap.
7. Position the swivel arm above the other filter and follow the above procedure once again if the model is equipped with two containers.
8. Once the container is empty the coffee maker is ready for use.

4.2 First settings operator menu

The following details are set in the operator menu immediately after being used for the first time.

Please note: The default language setting is English.

To gain access to the operator menu see chapter 11.

System settings (Systeminstellingen) (menu 2)

- | | |
|--------------|------------|
| 2.0 Language | See 12.3.1 |
| 2.1 Time | See 12.3.2 |
| 2.2 Date | See 12.3.3 |

Coffee settings (menu 3)

- | | |
|-----------------------|------------|
| 3.9 Descale indicator | See 12.4.7 |
| 3.10 Coffee dosing | See 12.4.8 |

You can study the remaining operator menu settings later.

The appliance is now ready for use.

5. OPERATING PANEL

5.1 Overview control panel buttons

CAUTION

- Never press de buttons with a sharp object.
- Protect the controls against dirt and grease.

The control panel contains a number of SOFT buttons and a graphic display. After the operator menu has been activated via a PIN, the selection, start and stop buttons have an extra function besides their basic functions.

Selection buttons (4x)

The selection buttons are used to select the standard brewing amount. The chosen amount is confirmed using the display and can be increased or decreased using the same selection buttons, as required.

STOP button

Use the STOP button to cancel a selection or to (emergency) stop a process. An emergency stop results in the process being lost, so it must be executed again. This button can also be used as a cancellation button if the operator menu is activated.

On/Off-switch

This switch is used to turn the coffee making system ON (I) or OFF (0).

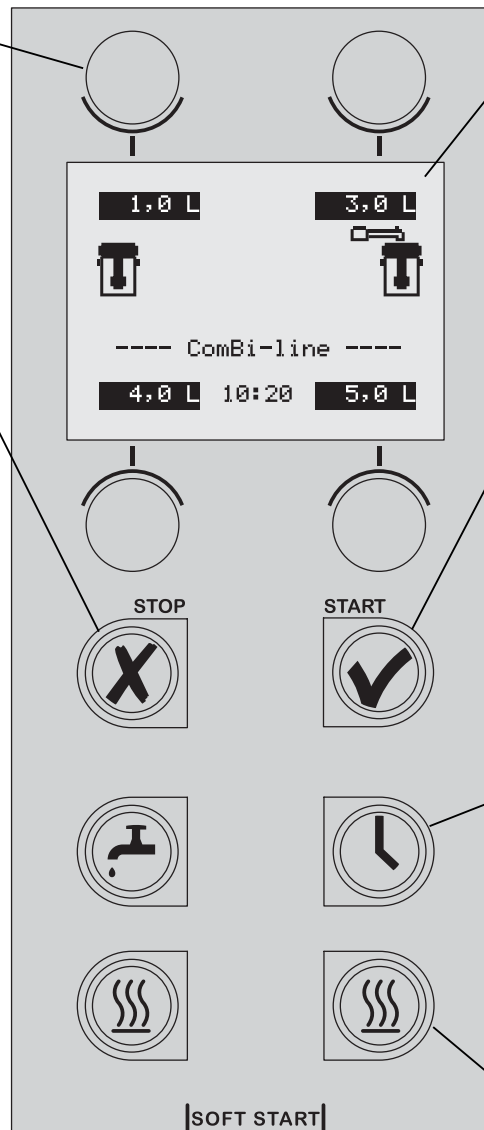

Display

The display informs the user about the status of the most important functions of the appliance. The following paragraph informs you about the different pictograms, text and their meanings.

START button

Use the START button to start a brewing process. First choose the brewing amount with one of the selection buttons. This button can also be used as a confirmation button if the operator menu is activated.

Timer button

Use the timer button to program the brewing process and/or the hot water system for use at a later point of time. §6.1.2.

Container heating buttons (2x)

Use the container heating button to switch the **power sockets** that are on the side of the column ON/OFF. ATTENTION: Only use the power sockets for the container heating, do not connect any other electrical appliances. (Maximum capacity 100W).

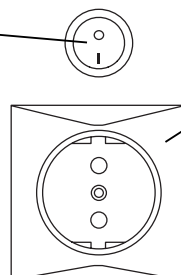

5.2 Overview display symbols

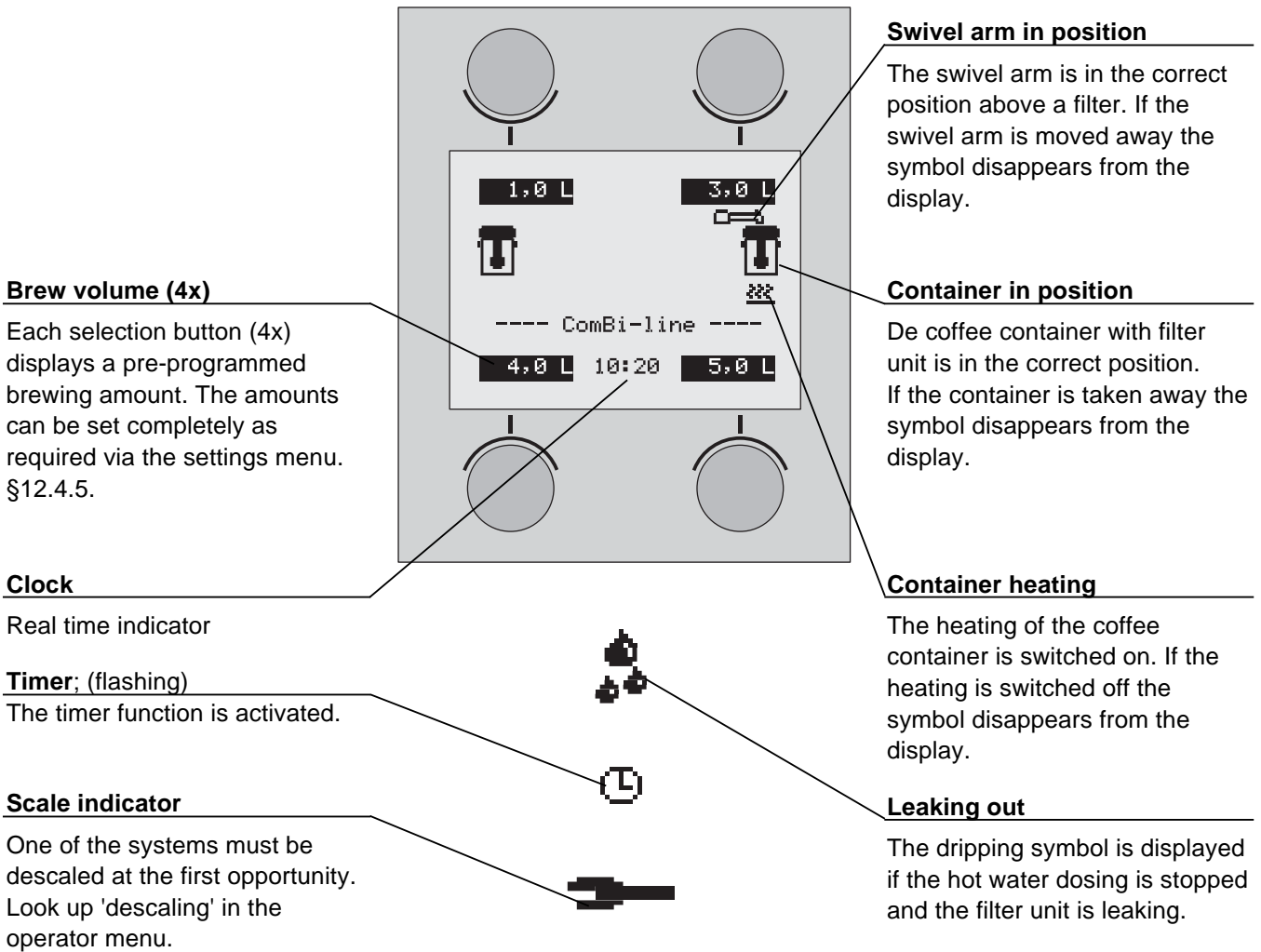

5.3 Overview error reporting symbols

Container position failure

This symbol appears in the display if the coffee container gets out of position during a brewing process. The arrow shows on which side the problem occurs.

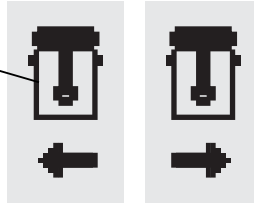

Swivel arm not in position

This symbol appears in the display if the swivel arm gets out of position during a making process. The arrow shows on which side the problem occurs.

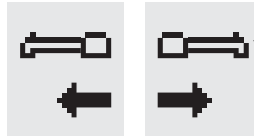

Swivel arm not in position for new brewing process

This symbol appears in the display if a brewing process is started and there is (still) no swivel arm in position above the filter unit.



Press START button

This symbol appears after the swivel arm and/or container fault has been resolved. For your own safety the start button must always be pressed again. If this report is responded to within 10 minutes the brewing process will restart and be completed.



If the START button is pressed only after 10 minutes, a cross symbol with a flashing clock appears in order to indicate that the brewing process can no longer be restored and should be considered lost.

6. DAILY USE

This chapter describes the daily use of the appliance by **partly qualified personnel**. When the machine is used for the first time, it works in accordance with the standard factory settings. The different settings can be changed later by **trained, qualified personnel**. See chapter 11-The operator menu for more details.

WARNING

- Inspect the appliance before using it and check it for damage.
- Never submerge or spray the appliance.
- Do not press the buttons with a sharp object.
- Protect the controls against dirt and grease.
- During use some parts will become very hot.
- Do not position the container on open fire or on a hotplate.
- First disconnect the electric cable before transporting the container.
- It is advisable to take the plug out of the socket and close the water tap if the appliance is not going to be used for longer periods of time.

Preparations

- Put the cables with inlet plug into the back of the container and insert the plug into the socket of the flow water heater (fig. 1-1).
- The inner pot of the container must always be fresh and clean.
- Place the coffee blender into the container. The blender guarantees a uniform quality of the coffee, which makes stirring the coffee (with loss of time, temperature and aroma) unnecessary. The temperature of the coffee is kept at a temperature of 80-85°C. The storage time of the coffee is determined by the blend of coffee and is usually 1 à 1,5 hours.

Basic rules for brewing coffee

- Use regular ground coffee (± 50 gram/liter)
- Keep the inner pot, filter unit and the mixer clean.
- Tip: always keep the basket filter paper in the original packing!
This means the paper keeps its original (basket) shape.
This prevents the paper from collapsing or not fitting in the filter.

figure 6

- A - Filter lid with water distributor
- B - Basket filter paper
- C - Basket filter
- D - Blender
- E - Insulated lid
- F - Container

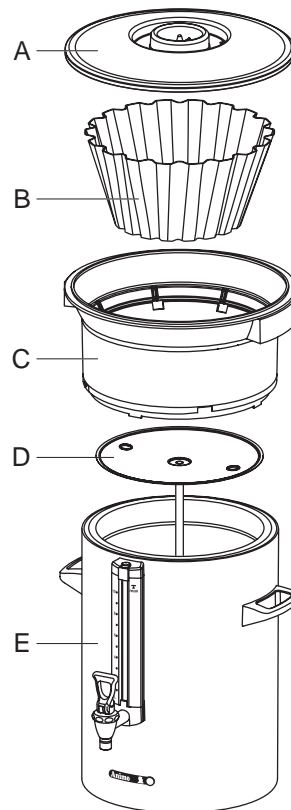

Container + accessories coffee Fig. 6

6.1 Brewing coffee

- Switch on the appliance by putting the ON/OFF switch (fig. 1-2) in position I, the display (fig. 7A) lights up and you will hear a beeping sound (1x short). Then the display indicates the standard brewing amounts.
- Select one of the four brewing amounts.
- The selected brewing amount including a recommended coffee dosage appears in the display (fig. 7B).
Tip: If you do not want the selected brewing amount, you can increase/decrease it with the + or - button. The recommended coffee dosage changes accordingly.
- Place a basket filter paper in the basket filter and fill it with the recommended brewing amount of coffee (standard ground). Spread the coffee evenly in the filter and then put the filter lid on.
- Place the filter unit on the container and position the swivel arm above the centre of the filter.
- Press the START button (fig. 1-4.7) to start the brewing process. In the display (fig. 7C) appears the text: **Processing**. The container heating switches on automatically, the heating should be switched off manually (fig. 1-4.9) if the container is empty. During the coffee brewing process, the display shows the selected brewing amount (fig. 7C below) and the amount of water already gone through the filter (fig. 7C above).
- When the water supply stops coming out of the swivel arm you will hear a beeping sound (1x short). In the display (fig. 7D) appears the text: **Leaking out**. The leak out time is set as standard to approx. 5 minutes, and its ending is indicated by a beeping sound (3x short).
- Remove the synthetic filter after it has been used and put the insulated lid on the container.
- Clean the synthetic filter.

After the brewing process you can draw off a cup of coffee by using the no-drip tap on the container.

Tip:

- If the swivel arm and/or the container are moved out of position before and/or during the brewing process, the brewing process will stop, a swivel arm and/or container symbol will appear in the display and you will hear a beeping signal (2x short). Once the positioning fault has been resolved the brewing process can be restored by pressing the START button. See 5.3 overview error reporting symbols.
- The brewing process can be interrupted at any moment with the STOP button (fig. 1-4.1). The brewing process should then be considered as lost.
- Prepare another brewing process by getting the second synthetic filter ready if required. Once the water supply has stopped coming from the swivel arm, you can position the swivel arm above the other filter and start a new brewing process immediately. The dripping symbol from the 1st container will then disappear.

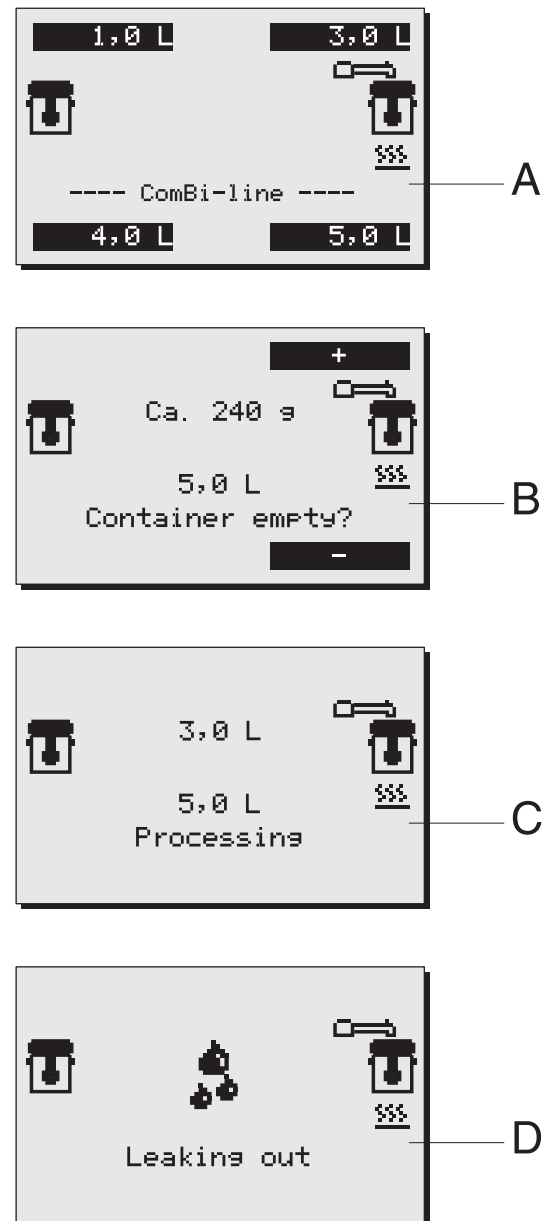

Brewing coffee

Fig. 7

6.1.1 Brewing tea

For the preparation of tea you can follow the same steps as the ones described for the coffee brewing process.

However, instead of using a coffee making unit, you should use a tea filter and disk (optional).

1. Put the tea, loose or in bags, in the tea filter, approximately 6 grams per liter.
2. Insert the tea filter into the disk (fig. 8B) already placed in the container.
3. Place the filling pipe (fig. 8A) on the tea filter. Then position the swivel arm over the pipe.
4. Select the brewing quantity and start the brewing process.
5. Remove the pipe and the tea filter after the tea has been made. ATTENTION: the filling pipe and filter are HOT!
6. After brewing put the insulated lid on the container to avoid loss of temperature and taste.
7. Clean the tea filter immediately after use.

Tip:

- The optimum extraction time is minimally 4 minutes and maximally 15 minutes. After more than 15 minutes the flavor of the tea deteriorates.

Figure 8

- A - Filling pipe
- B - Tea filter with disk
- C - Container with lid

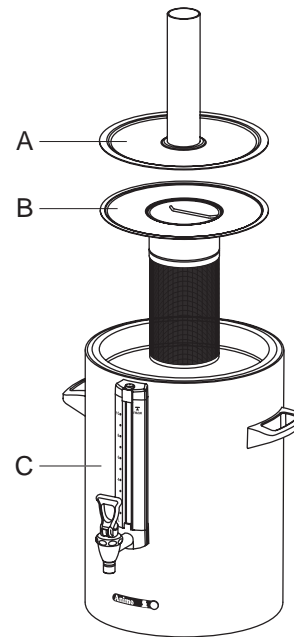

Container + accessories tea Fig. 8

6.1.2 Timer function

The appliance comes with a built-in timer clock as standard. You can use this to start a coffee brewing process and/or hot water system at a certain time.

1. Press the timer button (fig. 1-4.8).
2. Set the required start time (day/hour/min) with the left and right selection buttons (fig. 9A) and confirm your setting with the START button ✓. The day automatically moves to the next day when the hour setting goes past 24:00. Confirm your choice with the START button ✓.
3. Select the required brewing quantity (fig. 9B) and confirm your choice with the START button ✓ (fig. 9C) appears in the display.
4. Place a basket filter paper in the basket filter and fill it with the recommended brewing amount of coffee (standard ground) as shown in the display (fig. 9C). Spread the coffee evenly in the filter and put the filter lid on. Then place the filter unit on the container, and position the swivel arm above the centre of the filter. Tip: check if the container is empty. Confirm your choice with the START button ✓.
5. Explanation of the display (fig. 9D):
 Clock symbol (flashing): timer clock is activated
 The brewing quantity, start time and day are displayed.
 Swivel arm/container symbol: The coffee maker is ready.
 Tap symbol: The hot water system is ready.
6. The appliance may NOT be switched off!

Tip

- The timer clock function can only be cancelled by pressing the STOP button ✕.
- The container heating switches on automatically 5 minutes before the set time (pre-heating).
- The coffee brewing process and hot water system is switched off during an activated timer clock function. The container heating can be used normally, for example, to keep the coffee on the left warm, while on the right the coffee brewing process is pre-programmed.
- The timer can be programmed a maximum of 6 days in advance. This enables you to bridge a long weekend easily.
- The swivel arm and container safety devices remain active. If the swivel arm moves out of position, for example, it is detected immediately and a warning symbol appears in the display followed by a beeping sound (2x short). Once the swivel arm is moved back to the correct position, the timer clock is active again.

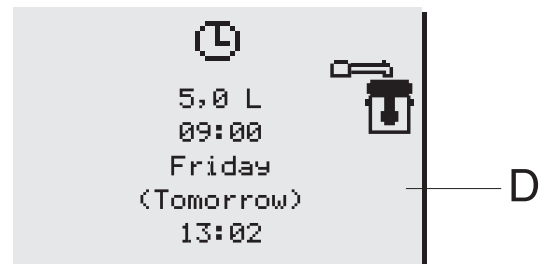
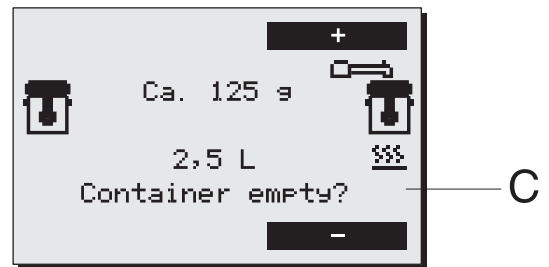
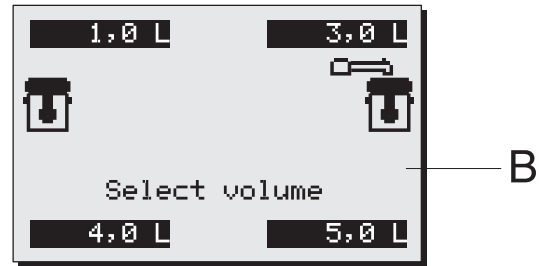
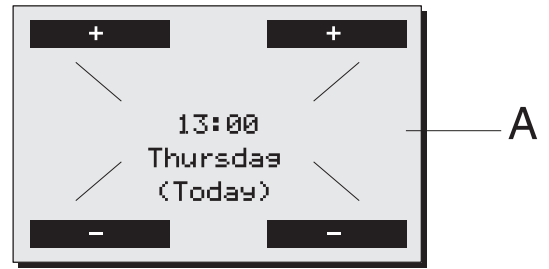

Timer display

Fig. 9

7. MAINTENANCE

Chapter 7.1 describes the daily cleaning activities of the appliance that can be carried out **by partly qualified personnel**. Chapter 7.2 describes the periodic descaling activities of the appliance that can only be carried out **by trained, qualified personnel**.

7.1 Cleaning

WARNING

- Do not leave the appliance unattended when maintenance is being performed.
- Never submerge or spray the appliance.
- The plug must be taken out of the socket if the appliance has to be opened for cleaning or repairs.
- Always follow the manufacturer instructions when using the scale remover.
- When descaling the appliance, it is advisable to wear safety glasses and protective gloves.
- Wash your hands after descaling.

7.1.1 Cleaning general

- The outside of the container can be cleaned with a wet cloth, then wiped dry. Never use any abrasives, as these can cause scratches and dull spots.
- Always take the connection lead out of the multiple socket during cleaning and maintenance activities and close it off with the splash protector (fig. 10B).
An opened splash protector (fig. 10A) protects the socket connection from moisture running in from above. A closed splash protector protects the multiple socket from dirt and moisture.
- Attention! Do not place the container type CNe (electrical execution) in the dish washer or sink.
- The container type CNi (insulated execution) is allowed to be cleaned in the dish washer or sink, because of its IP 65 construction.
- Do not leave the filter and the blender on a container which is not in use. Place the lid oblique on the container, otherwise a stale taste may be the result.
- Always leave some clean water (2 cups) in the container, This stops the washers from drying out.

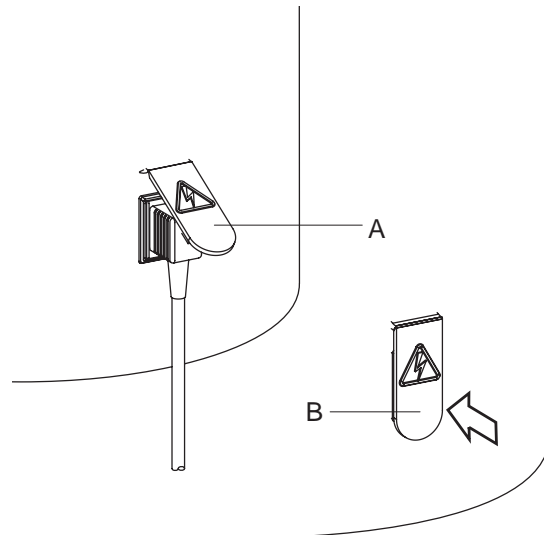

Electrical connection container Fig. 10

7.1.2 Cleaning daily

- Rinse the inner pot of the container after use with hot water, or use if necessary Animo coffee fur remover. Empty the container with the no-drip tap.
- The filter, water distributor lid, blender and drip tray can be washed normally and rinsed clean. The filter and water distributor lid are allowed to be cleaned in the dishwasher.
- Despite daily cleaning coffee deposits can still remain in the inner pot and the gauge glass, see chapter 7.1.3 until 7.1.5.

7.1.3 Cleaning weekly

A sachet of coffee fur remover is supplied with the machine.
Use is extremely simple.

Removal of coffee deposits from the inner pot.

1. Fill half of the container with warm water and dissolve a sachet of coffee fur remover in it.
2. Let the solution work for 15 to 30 minutes, then empty the container.
3. Rinse the container thoroughly with hot water a few times.

Removal of coffee deposits from the other parts.

1. Take a bowl filled with abt. 5 liter warm water and dissolve the coffee fur remover solvent from the sachet in it.
2. Put the parts that need to be cleaned in the bowl and soak them for 15 to 30 minutes.
3. Rinse several times with warm water. Repeat treatment if the result is insufficient.
4. Scatter coffee fur remover on very filthy spots and clean with a wet brush.

7.1.4 Cleaning the tap

1. Unscrew the top of the tap by turning it to the left.
2. Pull the silicon sealer vertically away from the screw top.
3. Put the parts to be cleaned in this solution and let it work for 15 to 30 minutes.
4. Then rinse off several times with warm water and put back together in reverse order, repeat if the results are insufficient.

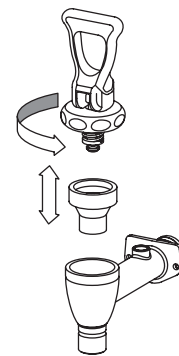

Cleaning tap

Fig. 11

7.1.5 Cleaning the gauge glass

WARNING

- Risk of burning! Empty the container before you remove the gauge glass for cleaning.
- Always treat the gauge glass with the necessary caution. Take the glass out of the protector with the help of a dry cloth and hold the gauge glass firmly with the cloth as you clean it with the gauge glass brush.

1. Empty the container, remove the filter and the coffee blender.
 2. Take the gauge glass lid (fig. 12A) off by pulling it vertically up from the protector profile.
 3. Take a dry cloth, and use it to take the top of the gauge glass (fig. 12C) from the recess and pull the gauge glass carefully diagonally up out of and loose from the tap connection.
 4. Remove the bottom tulle (fig. 12F) from the gauge glass and clean the gauge glass with the help of the supplied gauge glass brush. (careful fragile!)
 5. Moisten the gauge glass ends + tulle and put the tulle back in the glass and push the gauge glass into the tap connection with the tulle (fig. 12G).
 6. Always put the gauge glass lid (fig. 12A) vertically on the protector profile, push the top tulle with the index finger (in the middle of the gauge glass lid).
- Please note: make sure that the gauge glass lid stays firmly pushed against the container wall when placing it. Only then the gauge glass will stay well. (The lip in the gauge glass lid (fig. 12A) must be behind the holding plate (fig. 12B).

Tip: On the inside of the gauge glass protector is a spare gauge glass (fig. 12D). The assembly of the gauge glass system is much easier if you moisten the gauge glass ends and tulle well.

figure 12

- A - Gauge glass lid
- B - Holding plate
- C - Gauge glass
- D - Extra gauge glass
- E - Protector profile
- F - Lower tulle
- G - Tap cap

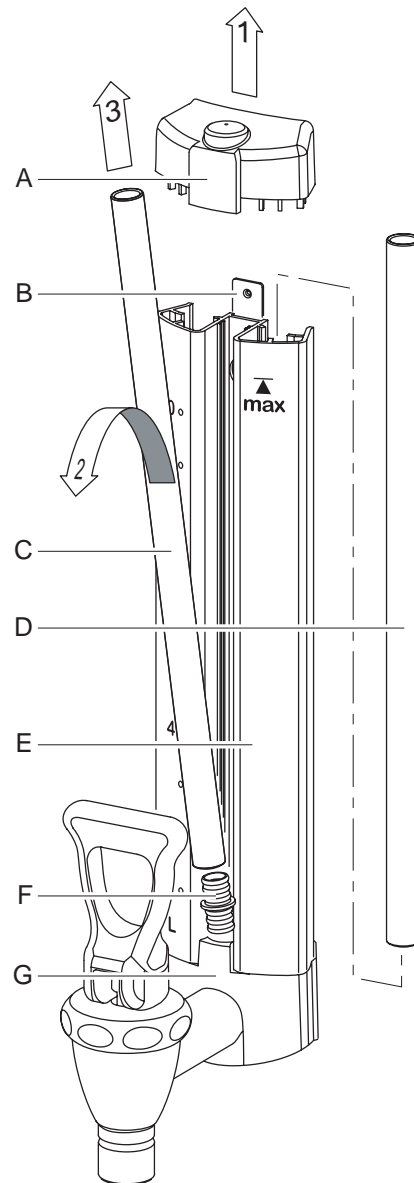

Cleaning gauge glass

Fig. 12

7.2 Periodic descaling activities

This chapter describes the periodic descaling activities of the machine that can only be executed by **trained, qualified personnel**.

WARNING

- Observe the descaling intervals indicated by the descaling indicator symbol.
- Overdue maintenance to the heating system can result in high repair costs and annulment of the guarantee.
- Always follow the manufacturer instructions when using the scale remover.
- Do not leave the appliance unattended when maintenance is being performed.
- When descaling the appliance, it is advisable to wear safety glasses and protective gloves.
- Wash your hands after descaling.

7.2.1 Descaling the coffee maker

After entering the Operator PIN you have access to the descaling menu where you can start the descaling program for the coffee maker. Follow the descaling procedure as described in chapter 12.2.2 of the operator menu.

8. TEMPERATURE PROTECTION

There temperature protections in the unit (fig. 1-5) that can be accessed from the outside. These protection switch off the temperatures rise too high. The most common cause for switching off is scale that has not been removed in time. If the temperature protection operates proceed as follows:

1. Let the unit cool down.
2. Unscrew the black protection cover.
3. Push the button that now appears and replace the black cover tightly.

When the protection was triggered due to scale formation, then proceed according to section 12.2. When scale formation was not the cause, then contact your dealer.

9. TRANSPORT

If the machine has to be transported, the water reservoirs must be emptied.

1. Switch the appliance off and remove the plug from the wall socket.
2. Remove the plugs from the containers and remove the containers.
3. Close the water outlet tap and disconnect the supply and overflow hoses.
4. Take the drain hose tap (fig. 1-8) out of the underside of the base plate, to drain the flow heater system completely, then close it off again. (Attention: the water can still be hot!).
5. The unit is now ready for (upright) transportation.
6. Proceed with section 3-INSTALLATION to reinstall the appliance.

10. CONSUMER ARTICLES AND ACCESSORIES

See the list below for the consumer articles and accessories available for the appliance. You can order these parts at your dealer, stating the details of the appliance given on the type plate, a description of the item, article number and quantity.

Consumer articles and accessories







	Description	Art.No.
	Coffee fur remover	per box (100 sachets of 10 gram) 49009 per can of 1Kg 00008
	Scale remover	per box (48 sachets of 50 gram) 49007 per can of 1Kg 00009
	Combi filter	Container CN5e 99238 Container CN10e 99239 Container CN20e 99240
	Coffee blender	Container CN5e 56004
		Container CN10e 96001
Container CN20e 56010		
	Basket filter paper	101/317 - container CN5e 01115 152/457 - container CN10e 01116 203/533 - container CN20e 01117
	Tea filter with disk	Container CN5e 57003
		Container CN10e 57005
Container CN20e 57011		
	Filling pipe	Container CN5e 17018 Container CN10e 17019 Container CN20e 17020
	S-swivelarm	With <input type="checkbox"/> Click it <input type="checkbox"/> connection for use on no-drip tap ComBi-line. 99497
	Container tube	99499
	Gauge glass brush	08094
	A - Upper tulle	04280
	B - Upper gauge glass cap	07954
	C - Gauge glass 5 litre	12884
	Gauge glass 10 litre	12885
	Gauge glass 20 litre	12886
	D - Lower tulle	04279
	E - Tap cap	07953
F - Seat cup	04034	
G - Under part gauge glass cap	07967	
	Cable + plug 1,5m	03072
	Cable + plug 0,6m	03071

TABLE OF CONTENTS

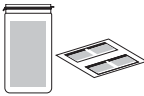
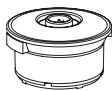
11.	THE OPERATOR MENU	66
11.1	Menu functions	66
12.	SETTINGS STEP BY STEP	67
12.1	Counters (Menu 0)	67
12.2	Descaling (Menu 1)	68
12.2.1	Flow counters (Menu 1.0)	68
12.2.2	Starting the coffee maker descaling program (Menu 1.1)	69
12.3	System settings (Menu 2)	71
12.3.1	Language (Menu 2.0)	71
12.3.2	Time (Menu 2.1)	71
12.3.3	Date (Menu 2.2)	71
12.3.4	Sound signal (Menu 2.3)	72
12.4	Coffee settings (Menu 3)	72
12.4.1	Volume of water (Menu 3.0)	73
12.4.2	Unit (Menu 3.1)	73
12.4.3	Cup volume (Menu 3.2)	73
12.4.4	Jug volume (Menu 3.3)	74
12.4.5	Changing the selection buttons (Menu 3.4 until 3.7)	74
12.4.6	Switching on the container heating automatically (Menu 3.8)	75
12.4.7	Coffee making descale indicator settings (Menu 3.9)	75
12.4.8	Coffee dosage (Menu 3.10)	76
12.4.9	Interval (Menu 3.11)	77
12.4.10	1 st charge (Menu 3.12)	78
12.4.11	Leak out time (Menu 3.13)	78
12.5	Load defaults (Menu 4)	79
13.	TROUBLESHOOTING	80

11. THE OPERATOR MENU

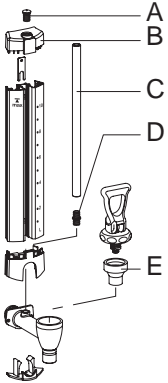
This chapter describes how the different settings can be changed by trained, qualified personnel. To gain access to the operator menu, read below. Once in the operator menu the control panel has the following functions:

Button  selection arrow → up

Button  selection arrow → down

Button  back (without saving changes)

Button  accept (activate)

11.1 Menu functions

You have the possibility of changing settings and have access to a number of maintenance functions via the operator menu.

It is possible to select the following functions:

Menu	Explanation of Operator menu	
0	Counters	see 12.1
1	Descaling	see 12.2
2	System settings	see 12.3
3	Coffee settings	see 12.4
4	Load defaults	see 12.5

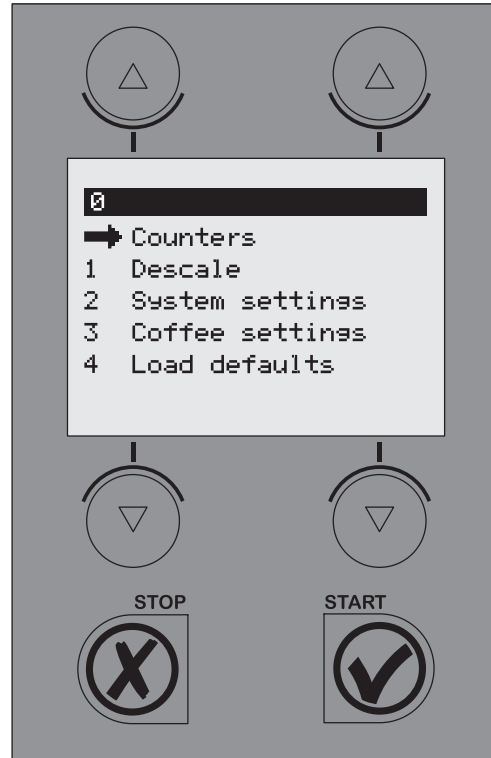

Operator menu

Fig. 13

How do you get access to the operator menu?

1. Switch the appliance off (0)
2. Hold the START button (fig. 1-4.7) and switch on (I) the ON / OFF switch (fig. 1-2).
3. Release the START button when the display lights up. In the display appears: Operator menu. Press any button.
4. Press any button. In the display appears:
Enter PIN: _ _ _ _ _
5. Look up the associated 5 digit PIN and enter it using the numbered buttons in the display (fig. 1- 4.3 to 1-4.6). Please note: the code number is produced at random, so the PIN is always different!
6. After entering the PIN the Operator menu will light up in the display.

Code no.	PIN
1	4 2 1 2 2
2	3 3 4 4 3
3	1 4 1 1 3
4	2 4 2 1 2
5	3 3 3 1 3
6	1 4 4 4 1
7	4 1 2 3 1
8	3 4 3 1 4
9	4 2 1 3 4
10	3 3 3 1 4
11	4 2 3 2 2
12	4 3 2 2 2
13	3 2 2 4 4
14	3 3 1 2 4
15	3 4 3 1 2
16	3 4 4 2 4
17	1 4 2 2 4
18	1 3 2 4 4
19	3 3 4 4 1
20	1 4 1 3 4

PIN table operator menu

How can you go through the menu and activate a function?

1. Move the arrow → to the required menu item using the selection buttons ▲ ▼ .
2. You activate the required menu by using the START button ✓ .
3. By pressing the STOP button ✕ you go back to the previous screen without saving the changes made.

How can you confirm a change?

You confirm a change by pressing the START button ✓ . You will hear a short beeping sound.

How can you close the operator menu?

1. Press the STOP button ✕ until the user menu reappears.
2. Check if the changed settings are as required. If the settings are not as required, follow the procedure again.

While you are in the settings menu the appliance will not fill or heat up.

12. SETTINGS STEP BY STEP

12.1 Counters (Menu 0)

PIN → Counters → then select counter item

An overview of all counter functions follows in the display. At the top of the display is a navigation bar on which the selected menu item number is shown.

Menu	Explanation of Counter items
0.0	Daily counter of coffee made in litres
0.1	Reset daily counter of coffee made
0.2	Total counter of coffee made in litres

1. Select the required counter, and confirm with the START button ✓ .
2. Read the counter reading or reset the counter as required.

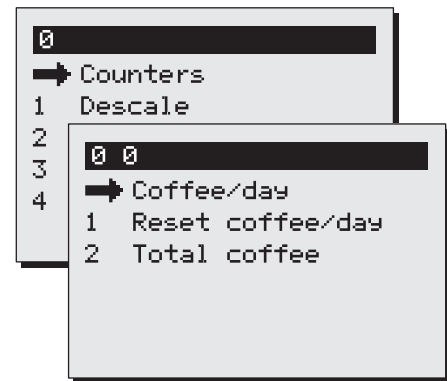

Counter menu

Fig. 14

12.2 Descaling (Menu 1)

PIN → Descaling → then select function

An overview of all descaling functions follows in the display. At the top of the display is a navigation bar on which the selected menu function number is shown.

Menu	Explanation of Descaling items:	
1.0	Flow counter	see 12.2.1
1.1	Start flow counter program	see 12.2.2

12.2.1. Flow counter (menu 1.0)

After activating the flow counter you can read how many litres away from a descaling signal the coffee maker is. Example: The diagram opposite indicates that the coffee making part (flow system) is still 961 litres away from a descaling signal. The counters are automatically reset after the relevant descaling program has been run.

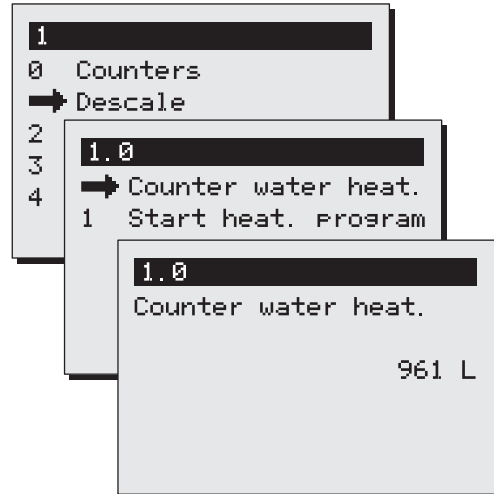

Descaling menu

Fig. 15

WARNING

- Respect the descaling intervals indicated by the descale indicator symbol.
- Delaying maintenance of the heating system can lead to high repair costs and can invalidate the guarantee.
- When descaling, always pay attention to the directions on the scale remover.
- Keep up with the maintenance requirements for the appliance
- It is advisable to wear safety glasses and protective gloves when descaling.
- Wash your hands thoroughly after descaling.
- All repairs should be carried out by a trained, competent service engineer.
- The plug must always be pulled out of the power socket whenever the appliance has to be opened for repairs and other (cleaning) purposes.

12.2.2 Starting the coffee maker descaling program (Menu 1.1)

This is where you start the descaling program for the coffee maker.

Preparation

- Move the swivel arm above an empty container and synthetic filter.
- Brew the smallest brewing amount (without coffee) once. The advantage of this is that the element is well preheated, so that descaling is better and takes less time.
- Carefully read the caution notice and the directions on the sachet Animo scale remover.
- Dissolve 2 sachets of 50 gram Animo scale remover into 2 litre of warm water (60°C). Stir the solution thoroughly so that the powder is completely dissolved.
- Remove the filter and place a plastic container under the outlet of the swivel arm to collect the scale remover.
- Follow the instructions shown on the display and confirm each action with **✓**.

Stopping the program?

The program can be cancelled at any time until the solution is poured in. Once the solution has been poured in, the program must always be completed. In case of an emergency stop, the STOP button **✗** can always be used. The program will then stop, but not be finished.

Display: 1/5 Place measuring cup. Press start **✓**.
Once the container is empty press the START button **✓**.

Display: 2/5 ← funnel left. Pour solution through. Ready? Press start **✓**.

- Remove the cap from the descaling opening left of the swivel arm (fig. 1-7).
- Insert the descaling funnel (fig. 17A) into the descaling opening. Push the funnel downward as far as possible.
- Slowly pour the scale remover into the funnel. The scale remover will enter the boiler element by the supply pipe and will come out of the swivel arm as foam.
- The descaling solution can be poured into the funnel a second time after it has been collected in the plastic container. As long as the scale remover comes out of the swivel arm foamingly, there are scale deposits in the appliance. Repeat the procedure described above with a new solution until no more foam comes out of the swivel arm.
- Press the START button **✓** to continue the program.

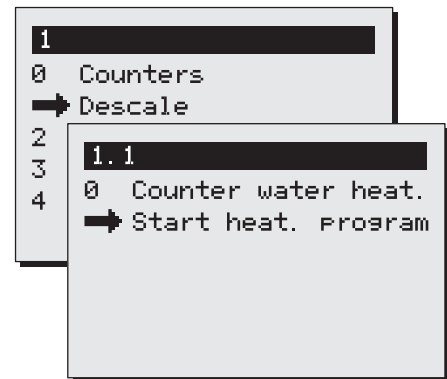

Start descaling program
coffee maker

Fig. 16

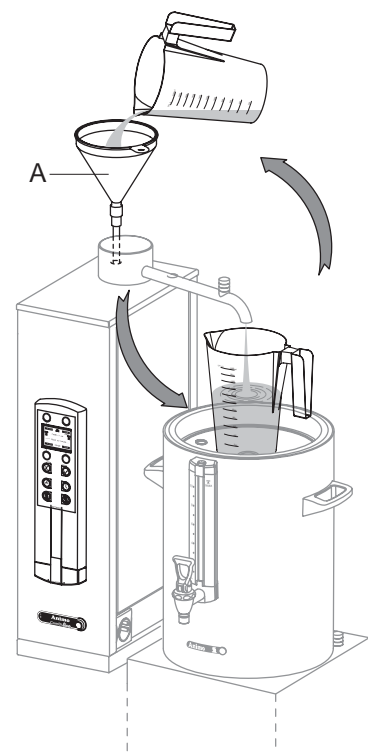
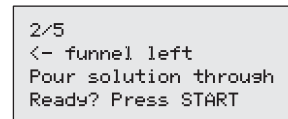
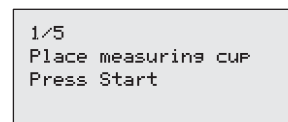

Descaling procedure

Fig. 17

Display: *2/5 Place filter. Press Start* ✓ .

The program is now ready to flush the system 3 times, so that the remaining scale remover can be removed from the heating system.

Remove the funnel and replace the cap.

Remove the plastic container with the collected scale remover and replace the filter.

Display: *3/5 Rinse. Press Start* ✓ .

Press the START button ✓ to start the 1st rins cycle.

Display: *3/5 Rinse. Please wait.*

The coffee maker will heat up.

The container will be filled with 2 litres.

There will be 3 beeping signals after the 1st rinsing cycle

Display: *3/5 Empty container. Press Start* ✓ .

Once the container is empty press the START button ✓ .

Display: *4/5 Rinse. Press Start* ✓ .

Press the START button ✓ to start the 2nd rinsing cycle.

Display: *4/5 Rinse. Please wait.*

The coffee maker will heat up.

The container will be filled with 2 litres.

There will be 2 beeping signals after the 2nd rinsing cycle.

Display: *4/5 Empty container. Press Start* ✓ .

Once the container is empty press the START button ✓ .

Display: *5/5 Rinse. Press Start* ✓ .

Press the START button ✓ to start the 3rd rinsing cycle.

Display: *5/5 Rinse. Please wait.*

The coffee maker will heat up.

The container will be filled with 2 litres.

There will be 3 beeping signals after the 3rd rinsing cycle.

Display: *5/5 Empty container. Press Start* ✓ .

Once the container is empty press the START button ✓ .

The descaling program is now complete and the descaling menu will reappear in the display. The flow counter will automatically be reset to the starting value. Exit the menu by pressing the STOP button twice, or select another menu function.

2/5
Place filter
Press Start

3/5
Rinse
Press Start

3/5
Rinse
Please wait

3/5
Empty container
Press Start

3/5 Serie

4/5
Rinse
Press Start

4/5
Rinse
Please wait

4/5
Empty container
Press Start

4/5 Serie

5/5
Rinse
Press Start

5/5
Rinse
Please wait

5/5
Empty container
Press Start

5/5 Serie

12.3 System settings (Menu 2)

PIN → System settings → then select function

An overview of all system settings follows in the display. At the top of the display is a navigation bar on which the selected menu function number is shown.

Menu Explanation of System settings items:

2.0	Language	see 12.3.1
2.1	Time	see 12.3.2
2.2	Date	see 12.3.3
2.3	Sound signal	see 12.3.4

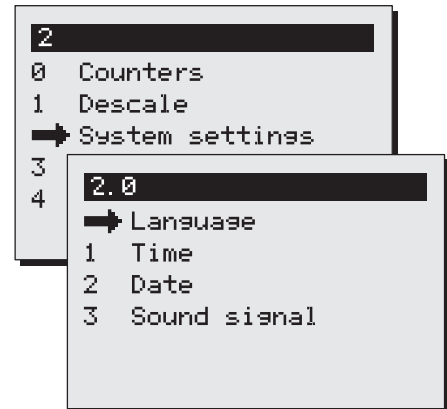

12.3.1 Language (Menu 2.0)

Before using the appliance you must first set the desired language. To select languages see fig. 18. The default language setting is English. Select the required language, and confirm your changes with the START button ✓.

Tip!: If Menu 5 Load defaults is activated, the altered language choices will remain unchanged.



12.3.2 Time (Menu 2.1)

Before using the appliance you must first set the time. See fig. 18. Use the left selection button to set the hour. Use the right selection button to set the minutes. Confirm your changes with the START button ✓.

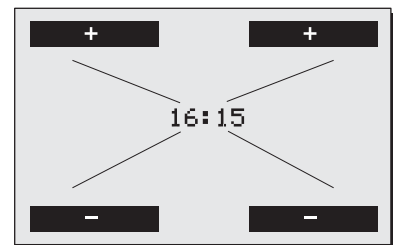

12.3.3 Date (Menu 2.2)

Before using the appliance you must first set the date. See fig. 18. Use the left selection button to set the day. Use the right selection button to set the month. The year count changes automatically every 12 months. Confirm your changes with the START button ✓.

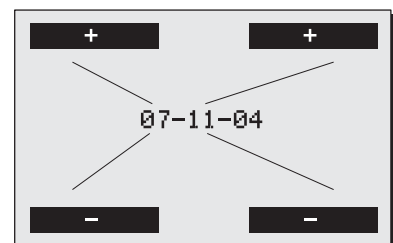

Systemsettings
Language / Time / Date

Fig. 18

12.3.4 Sound signal (Menu 2.3)

When in use the appliance makes different sound signals. You can switch the sound signals off if desired. See fig. 19. Select the required choice and confirm your changes with the START button ✓.

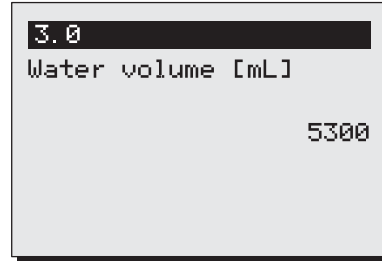

System settings
sound signal

Fig. 19

12.4 Coffee settings (Menu 3)

PIN → Coffee settings → then select function

An overview of all coffee settings follows in the display. At the top of the display is a navigation bar on which the selected menu function number is shown.

Menu	Explanation of coffee settings items:	
3.0	Water volume	see 12.4.1
3.1	Unit	see 12.4.2
3.2	Cup volume	see 12.4.3
3.3	Mug volume	see 12.4.4
3.4	Button 1	see 12.4.5
3.5	Button 2	
3.6	Button 3	
3.7	Button 4	
3.8	Auto container heating	see 12.4.6
3.9	Descale indicator	see 12.4.7
3.10	Coffee dosage	see 12.4.8
3.11	Interval	see 12.4.9
3.12	1st charge volume	see 12.4.10
3.13	Leak out time	see 12.4.11

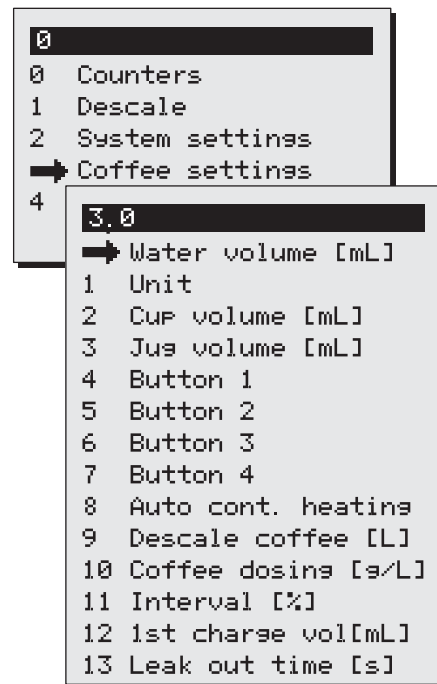

Coffee settings

Fig. 20

12.4.1 Water volume (Menu 3.0)

WARNING

- The container will overflow if too large an amount is set.
- The manufacturer accepts no responsibility for the consequences of changed settings.

During use, it can occur that the quantity of water in the container is not as required. This depends on the amount of coffee and the size of coffee ground used. The amount of water that comes out of the swivel arm is set to 6% - 10% extra water as standard. Table 1 shows the settings scope.

Model	Factory-settings	Settings
CB 5	5.300 ml	4.800-5.800 ml
CB 10	10.800 ml	9.800-11.800 ml
CB 20	22.000 ml	20.000-24.000 ml

Table 1. *Water volume*

Increase or decrease the water volume [ml] with the selection buttons above and below the display.
Confirm the changes made with START button ✓ or go back without making any changes by pressing the STOP button ✕ .

12.4.2 Unit (Menu 3.1)

You can change the unit in which the selection buttons are shown in the display with this function. The unit can be set as Litres (standard), Jug or Cup.

Select the required unit and confirm your changes with the START button ✓ or go back without saving any changes using the STOP button ✕ .

Please note: The counter menu continues to be displayed in litres.

12.4.3 Cup volume (Menu 3.2)

You can change the volume of the cup with this function. The cup volume is set to 125 ml as standard. The settings scope is between 100 and 500 ml (1 ml steps).

Set the required cup volume and confirm your changes with the START button ✓ or go back without saving any changes by pressing the STOP button ✕ .

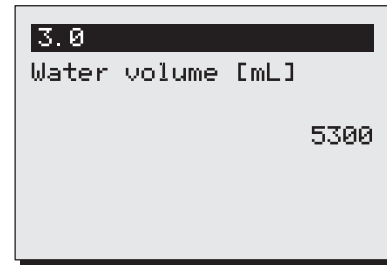

Change volume of water

Fig. 21

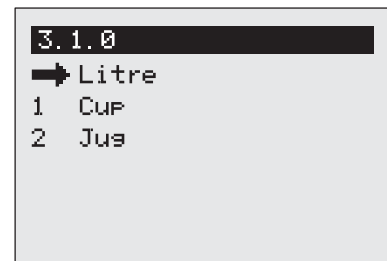

Unit

Fig. 22

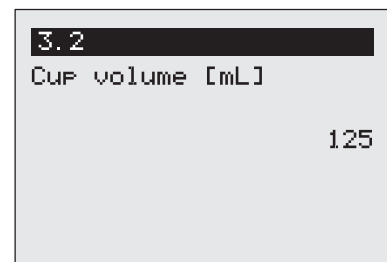

Change cup volume

Fig. 23

12.4.4 Jug volume (Menu 3.3)

You can change the volume of the jug with this function.

The jug volume is set to 250 ml as standard

The settings scope is between 200 and 2500 ml (1 ml steps).

Set the required jug volume and confirm your changes with the START button ✓ or go back without saving any changes by pressing the STOP button ✕ .

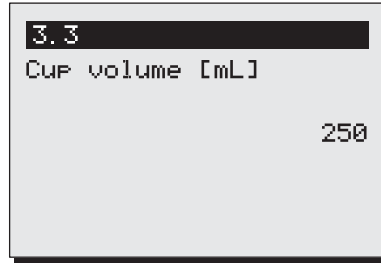

Change cup volume

Fig. 24

12.4.5 Changing the selection buttons (menu 3.4 until 3.7)

You can set each selection button as required with this function. The four selection buttons (fig. 25) are set in the factory as shown in the overview below (Table 2).

With the help of **Buttons 1 to 4** (menu 3.4 to 3.7), the choice can be set within the scope with associated step size indicated in the table below.

Model	Factory settings	Settings scope	Step
CB 5	1-3-4-5 litre	1- 5 litre	0,5 l
CB 10	2,5-5-7,5-10	2- 10 litre	0,5 l
CB 20	5-10-15-20	4- 20 litre	1 l

Table 2. Selection buttons unit litres

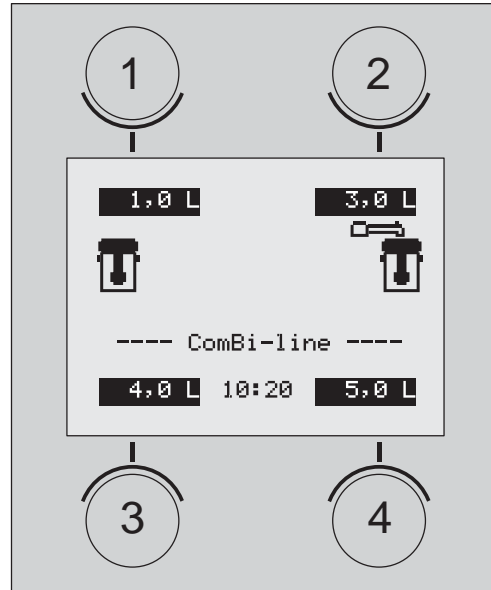

Changing the Selection

Fig. 25

Set the required amount for button 1 and confirm your changes with the START button ✓ or go back without saving any changes by pressing the STOP button ✕ . Repeat this for buttons 2 to 4.

Have you changed the unit of Litres to Cup or Jug?

The litre setting is automatically calculated by the relevant litre setting divided by the cup or jug volume. The four selection buttons then automatically have the settings as shown in the following overview (Table 3 + 4) Each selection button within the settings scope and associated step size can be set with the help of the menu buttons 3.4 to 3.7.

Model	Factory settings	Settings scope cup = 125 ml	Step
CB 5	8-24-32-40	8- 40 cups	1 cup
CB 10	20-40-60-80	16-80 cups	1 cup
CB 20	40-80-120-160	32-160 cups	5 cup

Table 3. Selection buttons unit cups

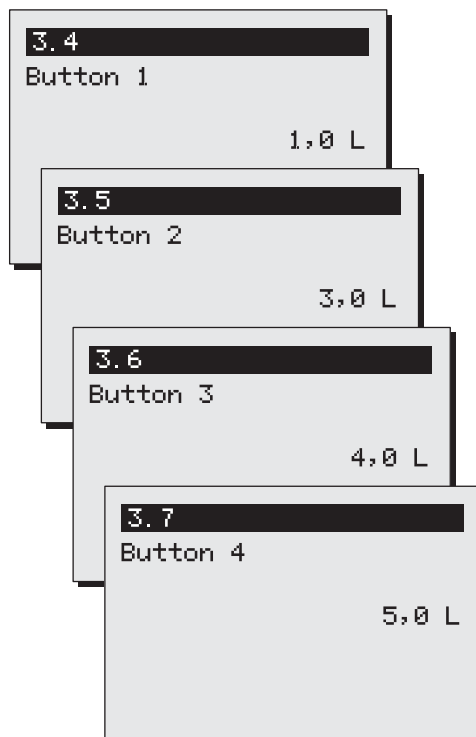

Button 1, 2, 3 and 4

Fig. 26

Model	Factory settings	Settings scope jugs = 250 ml	Step
CB 5	4-12-16-20	4-20 jugs	1 jug
CB 10	10-20-30-40	8-40 jugs	1 jug
CB 20	20-40-60-80	16-80 jugs	1 jug

Table 4. Selection buttons unit jugs

12.4.6 Switching on the container heating automatically (menu 3.8)

When starting a coffee making process the appliance automatically switches the right container heating on. The container heater then stays switched on and must always be switched off manually. You can switch this function off if required. See fig. 27.

Select the required choice and confirm your changes with the START button ✓ or go back without saving any changes by pressing the STOP button ✕ .

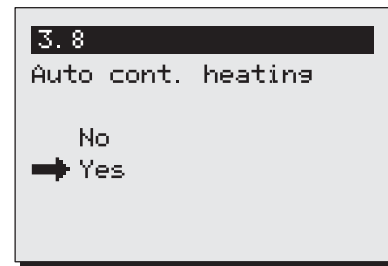

Auto container verwarming

Fig. 27

12.4.7 Coffee making descale indicator settings (menu 3.9)

Before you start using the appliance you must first set the descale indicator.

- The default descale indicator is set to 1000 litres (average water hardness) and has a scope of 0 to 9999 litres in steps of 100
- Use the table 5 below and select the relevant water hardness in the left column (°D). On the right you can read after how many litres (recommended) the system must be descaled.
- Once the set amount of litres has been reached a spanner symbol will appear in the display. The appliance will continue to work normally so that descaling can be done at a more suitable time.
- In the Descaling menu 1.0 you can see how many litres away from a descale indicator signal the system still is.

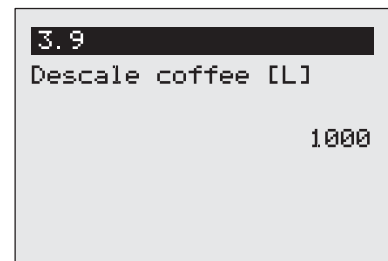

Coffee making descale indicator settings

Fig. 28

Water quality	Hardness				Descal indicator litres
	°D	°F	mmol/l	mgCaCo3/l	
Very hard	18-30	32-55	3,2-5,3	321-536	250
Hard	12-18	22-32	2,2-3,2	214-321	500
Average	8-12	15-22	1,4-2,2	268-214	1000*
Soft	4-8	7-15	0,7-1,4	72-268	1500
Very soft	0-4	0-7	0-0,7	0-72	2000

Table 5.

Water hardness

* Standard settings

Set the required number of litres and confirm your changes with the START button ✓ or go back without making any changes using the STOP button ✕ .

- Contact your local water company if you are unsure about the hardness of your tap-water.

12.4.8 Coffee dosage (menu 3.10)

When an amount is selected, the recommended amount of ground coffee (grams) that should be put in the filter unit in order to make the selected amount of coffee appears in the display. The amount of coffee is set to 50 grams/litre as standard and can be set from 0 to 100 grams in steps of 1 gram.

Set your coffee dosage and confirm your changes with the START button ✓ or go back without saving any changes by pressing the STOP button ✕ .

Tip: If the coffee dosage advice is not desired you can switch it off by setting the grams/litre value to 0.

Please note: When setting larger amounts of coffee a negative correction factor is applied to the calculation. This means that the coffee dosage advice is lower than the result of the calculation 'brewing quantity x coffee dosage'.

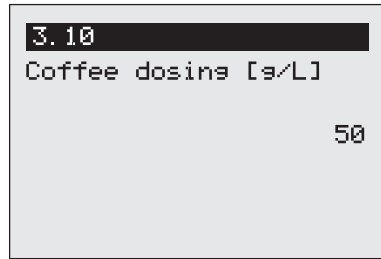

Coffee dosage settings

Fig. 29

12.4.9 Interval (menu 3.11)

Using very finely ground coffee or very soft water will result in the water running through the coffee filter more slowly. Pausing the hot water pouring after the 1st charge volume (half way through the making process) for periodic intervals (that can be set) can prevent the coffee filter from overflowing.

Interval Settings

- The interval is set to 100% as standard. The brewing process can then run smoothly.
- The interval can be set from 100% to 50% in steps of 5%. After a setting has been made the controller calculates the time out interval itself (see table 6).
- If the hot water pouring switches to the interval mode after the 1st charge, the water supply and pausing will continue until the required volume has been reached.
- The interval setting and the 1st charge volume can only be determined by trial and error by keeping an eye on the filtering process during the coffee making.

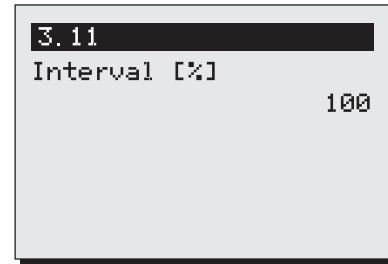

Interval

Fig. 30

Set the required number of litres and confirm your changes with the START button ✓ or go back without saving any changes by pressing the STOP button ✕ .

Interval	Water pouring time	Interval-time (pause)
100%	Continue	0 sec
95%	45 sec	4,5 sec
90%	45 sec	9 sec
85%	45 sec	13,5 sec
80%	45 sec	18 sec
75%	45 sec	22,5 sec
70%	45 sec	27 sec
65%	45 sec	31.5 sec
60%	45 sec	36 sec
55%	45 sec	40.5 sec
50%	45 sec	45 sec

Table 6. Interval overview

12.4.10 1st charge (menu 3.12)

The 1st charge volume can be increased if it is only found out later in practise that the filtering process threatens to overflow

Setting the 1st charge volume

- The 1st charge volume only becomes active if the interval is set at 95% or less.
- The 1st charge volume is set for half way through the brewing process as standard.
- The 1st charge volume can be set according to the following overview (Table 7).

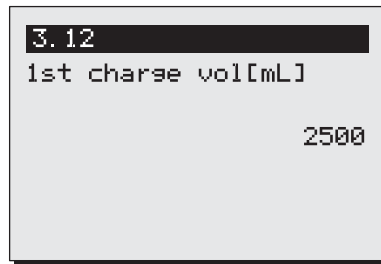

1st charge volume (CB5W)

Fig. 31

Set the desired 1st charge volume and confirm your changes with the START button ✓ or go back without making any changes using the STOP button ✕ .

Model	Standard 1 st charge	Settings scope	Step
CB 5	2.500 ml	2500 - 4500 ml	250
CB 10	5.000 ml	5000 - 9000 ml	250
CB 20	10.000 ml	8000 - 18.000 ml	250

Table 7. 1st charge volume settings scope

12.4.11 Leak out time (menu 3.13)

The leak out time starts once the hot water distribution is stopped. The leak out time through the filter can vary depending on the type, size and/or amount of coffee.

Leak out time settings

- If no leak out time is required the time can be set to 0. There will then be no dripping symbol in the display followed by a sound signal.

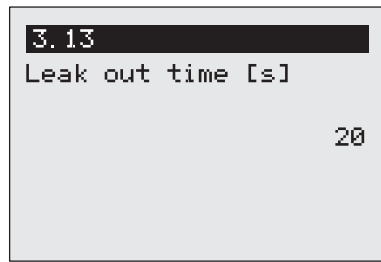

Leak out time

Fig. 32

Set the required leak out time and confirm your changes with the START button ✓ or go back without saving any changes by pressing the STOP button ✕ .

Model	Standard leak out time	Settings scope	Step
CB 5	240 sec	0 - 900	10
CB 10	300 sec	0 - 900	10
CB 20	360 sec	0 - 900	10

Tabel 8. Leak out time

12.5 Load defaults (menu 4)

You can restore all the default settings except for the language setting with this function. Please note: All settings that you have changed in the operator menu will be lost.

Press the START button ✓ to load the default settings or go back without making any changes by pressing the STOP button ✕ .

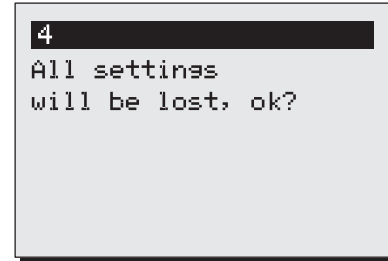

Load defaults

Fig. 33

13. TROUBLESHOOTING

WARNING

- Have all repairs to the electrical system performed by a qualified service technician.

If your appliance is not functioning correctly, use the troubleshooting guide below to see whether you can resolve the problem yourself. If not, please contact your dealer.

Error message Display	Possible cause	Action
C2 (coffee)	Coffee maker doesn't work. Dry-boil protection switched off.	Reset dry-boil protection coffee making unit (fig. 1-5). Check to see if the coffee maker needs to be descaled, and descale if necessary.
C3 (coffee) I	Coffee maker doesn't fill any more.	Check the water pressure, turn the water supply taps completely open, check if the connecting hose is fastened. Problem solved, error message disappears.
C3 (coffee) II	Coffee maker fills too slowly.	Check the water pressure, turn the water supply taps completely open, check if the connecting hose is fastened.
C4 (coffee)	Water inlet valve doesn't close properly.	Call the service engineer or dealer.
C7 (coffee)	Minimum electrode fault.	Call the service engineer or dealer.
C8 (coffee)	Error C3 changes to C8 after 10 minutes. The inlet valve is closed for safety. Please note: this also happens when the max level is reached!	Restore water supply and restart the coffee making process.
C9 (coffee)	Problems with registering the volume of water.	Call the service engineer or dealer.

Animo

Animo B.V. Headoffice
Dr. A.F. Philipsweg 47
P.O. Box 71
9400 AB Assen
The Netherlands

Tel. no. +31 (0)592 376376
Fax no. +31 (0)592 341751

E-mail: info@animo.nl
Internet: <http://www.animo.nl>



Accredited by
the Dutch Council
for Certification

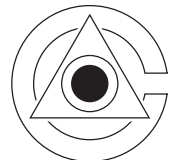

Rev. 1 07/04 Art.nr 09866