

**MOD : CPE664-BG****Production code : P011207DIA**

# INSTALLATION, OPERATING AND MAINTENANCE MANUAL: CONVECTION OVENS

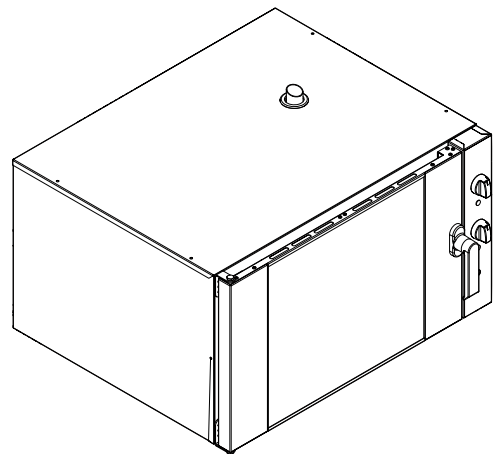
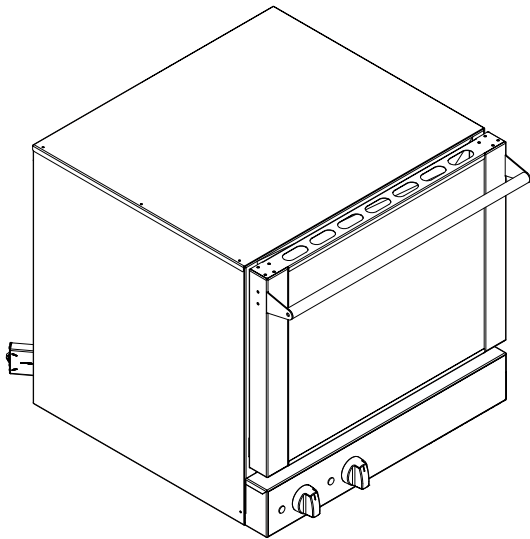

<b>EN</b> Installation, operating and maintenance manual .....	17
--	----

\* *Original instructions*



## Table of contents

1.	WARNINGS .....	18
1.1	Appliance description .....	19
1.2	Transportation and handling .....	19
1.3	Operating conditions and technical specifications .....	19
1.4	Installation .....	20
1.5	Electrical connections .....	20
1.6	Hydraulic connections .....	21
1.7	Reasonably foreseeable misuse .....	21
1.8	Operation/use .....	21
1.9	Total shutdown .....	21
1.10	Routine cleaning and maintenance .....	21
1.11	Unplanned maintenance .....	22
1.12	Disposal .....	22
2.	INTRODUCTION .....	23
3.	APPLIANCE DESCRIPTION .....	23
4.	TRANSPORTATION AND HANDLING .....	24
5.	OPERATING CONDITIONS AND TECHNICAL SPECIFICATIONS .....	24
5.1	Rating plates .....	24
5.2	Analogue controls .....	25
5.3	Digital controls .....	25
6.	INSTALLATION .....	26
6.1	Controlling the appliance upon receipt .....	26
6.2	Positioning .....	26
6.3	Preparations to be made by the client .....	26
6.4	Electrical connections .....	26
6.5	Hydraulic connections .....	26
7.	OPERATION/USE .....	27
7.1	Intended use and restrictions .....	27
7.2	Switching on the oven for the first time .....	27
7.3	Start up and shutdown phases .....	27
7.4	Digital thermostat operation .....	27
7.5	Total shutdown .....	28
7.6	Remedies to cooking hitches .....	28
8.	CLEANING AND MAINTENANCE .....	29
8.1	Routine maintenance .....	29
8.2	Unplanned maintenance .....	29
9.	DISPOSAL .....	29
10.	ATTACHED DOCUMENTATION .....	29
11.	TECHNICAL FEATURES .....	59
11.1	Analog oven with flag door .....	59
11.2	Analog and digital combi-oven with flag door .....	61
11.3	Analog oven with tilting door .....	62



## INSTALLATION, OPERATING AND MAINTENANCE MANUAL: ELECTRIC OVEN UNITS

### 1. WARNINGS

The contents of this manual are generic and not all the functions described may be available on your product. The manufacturer declines all responsibility for possible inaccuracies contained in this pamphlet, due to printing or copy errors. We reserve the right to make on our own products those changes to be considered necessary or useful, without jeopardizing the essential characteristics.

Read this manual carefully before commencing installation.

The manual has been designed to provide the user with all the information required to use the appliance safely, from its transportation right through to its disposal. In order to properly understand the document, you must be familiar with the terms and symbols used; these are summarised below:

 WARNING – Health and safety hazard for the persons involved

 WARNING – Electrical hazard - Dangerous voltage

 Read the instruction manual before using the appliance.

The manual must be stored carefully so that it can be used for future reference. If the appliance changes hands, the manual must also be handed over to the new user.

This documentation is also made available by the manufacturer in digital format.

In order to use the appliance correctly:

- Do not remove or tamper with the safety devices;
- It is prohibited to perform any checks, cleaning operations or maintenance works on moving parts;
- Only use the appliance for the purposes for which it was specifically designed;
- Keep unauthorised personnel away from the appliance;
- It is prohibited for people under the age of 18 or adults with limited physical or mental abilities to use the appliance;
- Have maintenance performed exclusively by qualified personnel;
- Switch off the appliance in the event of a fault or malfunction;
- Disconnect the equipment when cleaning the machinery;
- Only use the spare parts supplied or indicated by the Manufacturer;
- Ensure the oven is on a stable position and safety devices installed upstream are efficient;
- Always use adequate protection gloves to introduce or pull out the trays;
- Have the machine periodically checked by qualified technicians;
- Often clean the oven following the instructions stated in this manual;
- Don't put trays or other kitchen tools on the oven;
- In order to avoid burns, never use trays or containers with liquids or fluids over a level that can be easily controlled at sight;
- Always pay maximum attention to the floor, that due to cooking steam could be slippery;
- Ensure proper lighting and ventilation according to legal regulations;

 Attention: only qualified personnel are authorised to access the main control board and any other electrical parts, whether for installation or maintenance purposes.

The Manufacturer declines all responsibility for damage to property or bodily injury caused by the failure to follow the instructions and warnings contained in the manual. If in any doubt, and whenever the need arises, contact the Dealer.

## 1.1 Appliance description

Our electric convection, convection with manual humidification and combi ovens are made of AISI 430 and/or 304 stainless steel with sealed cooking chamber and rounded corners for better cleaning and hygiene.

They are equipped with a flap or flag door, the latter with a folding glass on hinges for easy cleaning. The maximum operating temperature is 270°C. The control panel on the front is analogue or digital depending on the models.

Some models are also equipped with:

- autoreverse system that allows the fan(s) to automatically change rotation for better uniformity in heat distribution
- drain for water resulting from internal moisture and cleaning operations
- upper internal heating element for Grill mode

The equipment conforms to the 2014/35/UE, 2014/30/UE ed 1935/2004/CE

In addition, the following standards have also been applied: EN 60335-1, EN 60335-2-36, EN 61000-3-2, EN 61000-3-3, EN 55014.1 ed EN 55014.2.

The sound pressure level is less than 70 dB.

## 1.2 Transportation and handling

 If the appliance is transported on a pallet, it must be unloaded by trained personnel using a forklift or other suitable lifting equipment. During loading and unloading operations, it is prohibited to stand under suspended loads. Any manoeuvring errors could cause crushing injuries.

Any blows to the surfaces of the appliance could result in immediate damage.

During this phase, anyone not directly involved in the operation must not be allowed to remain in the area.

The personnel handling, positioning, assembling or disassembling the appliance, must be qualified and wearing suitable personal protective equipment (e.g. work gloves, safety shoes).

## 1.3 Operating conditions and technical specifications

The equipment covered by this manual is designed solely for cooking food and the regeneration of precooked and/or refrigerated food. The maximum operating temperature is about 270°C, but may vary depending on the environmental conditions in which the equipment is located.

 Warning: the appliances are not suitable for outdoor installations and/or environments subjected to the weather (rain, direct sunlight, etc.).

 Warning: do not store explosive substances such as pressurised containers or items containing a flammable propellant inside these appliances.

 Warning: before installing the appliance, make sure that the electrical connection preparations comply with the information indicated on the rating plate. It is prohibited to remove or modify the rating plate or any other warning label.

 Warning: In order to avoid burns, never use trays or containers with liquids or fluids over a level that can be easily controlled at sight.

## 1.4 Installation

Before unpacking the appliance, check that the outer protective casing is fully intact. Any damage must be promptly reported to the courier. In any case, no damaged appliance can be returned to the manufacturer without prior notice and without prior written authorisation.

 The described operations must be carried out by qualified personnel. Before performing any installation procedure, disconnect the appliance from the power mains.

Set down the appliance where desired using a pallet truck. If the unit is moved after it has been unpacked, protect the surfaces from knocks. Once the installation has been carried out, the protective film can be removed. This operation should be performed very slowly to prevent the glue from remaining on the surfaces. Take the protective film off by hand before starting the appliance. Do not use abrasive substances and/or metal objects.

Use an earthed socket with an adequate capacity for the absorption indicated on the rating plate.

Depending on the model, the equipment is supplied with or without a power cable. In any case, connection to the mains supply must be carried out by qualified personnel.

Before installing the appliance, check the load-bearing capacity and flatness of the surface on which it is to be placed. Incorrect levelling can cause the appliance to malfunction.



## 1.5 Electrical connections

 They must be carried out in accordance with the local regulations in force. Before performing the electrical connection, make sure that the voltage and frequency correspond to the information indicated on the appliance's rating plate. The electrical connection is carried out by connecting the appliance's plug to a socket in the room; this socket must still remain accessible after the installation. If the purchased oven does not have a power cable, the connection must be made by qualified personnel by connecting the cable to the terminal board. The distance between the oven and the socket must be such that the power cable is not stretched.

Use cable type H07RNF or equivalent and an efficient and correctly sized earth conductor according to the total power of this appliance (see rating plate).

The electrical circuit of the unit is designed to operate at a power supply voltage in accordance with the configurations shown in the rating plates of all models (**A**), with a frequency of 50/60Hz. See the electrical diagram of the model you have purchased.

If the power cable is damaged, it must be replaced by the customer service or qualified personnel. The appliance's electrical supply system must be equipped upstream with an appropriately-sized automatic omnipolar circuit breaker that ensures a gap of at least 3 mm between the contacts. There must not be any breaks in the earth cable.

 The electrical safety of this appliance is only guaranteed when the above-mentioned conditions are met and if the system's equipotential situation is also compliant (use the connection screw located near the power cable input and the symbol sticker ).

 Any operations carried out on electrical systems must be performed by qualified personnel. The manufacturer declines all responsibility in the event that these safety standards are not complied with.

## 1.6 Hydraulic connections

If the humidification system is installed (optional), the ovens have a water inlet coupling at the back. Always install an on-off valve between the appliance and the water mains, making sure it is easy to operate. We also suggest installing a cartridge filter on the water inlet pipe.

Always use a set of new water joints, eventual old joints must not be used again.

Plumbing connection must be always effected with cold water and rigid pipes. Never use hoses to connect the oven to the water main.

## 1.7 Reasonably foreseeable misuse

Any use other than what is specified in this manual is considered improper. When using the machine, work or activities that may pose risks to the safety of the workers or cause damage to the appliance are not permitted. Improper use includes:

- Placing the appliance in a weather-exposed outdoor area.
- Incorrectly installing the machine.
- Changing or tampering with the safety devices.
- Making changes or tampering with the appliance's electronic elements.
- Not complying with the deadlines for periodic checks, maintenance and cleaning.
- Placing or storing flammable or explosive materials in the immediate vicinity of the machine.

## 1.8 Operation/use

- Clean the steel parts with a neutral detergent and a damp cloth. Avoid using abrasive detergents or scouring powders. The manufacturer declines all responsibility if the products are not used as intended.
- The equipment covered by this manual is designed solely for cooking food and the regeneration of precooked and/or refrigerated food. Any other use shall be considered improper.
- The machines have not been designed for use in unsupervised environments. Furthermore, the appliances are not suitable for outdoor installations and/or environments subjected to the weather (rain, direct sunlight, etc.).
- Do not store explosive substances such as pressurised containers or items containing a flammable propellant.

## 1.9 Total shutdown

When the unit is to be decommissioned for a lengthy period, the following measures must be taken:

- Turn the main switch off
- Close the water on-off valve (if the oven is connected to the water supply);
- Leave the door open so air can circulate and prevent bad odors;
- With a cloth spread a thin protective layer of Vaseline oil on all stainless steel surfaces;

## 1.10 Routine cleaning and maintenance

The appliance must only be cleaned after the power supply upstream from the appliance has been disconnected.

During the maintenance operations, the cable and the plug must be always visible and accessible for the operator who is performing the operations.

The routine and preventive maintenance essentially entails cleaning the stainless steel parts with warm water and mild soap on a weekly basis, and then rinsing and drying these thoroughly.



The oven cooking chamber must be cleaned at the end of each cooking process to remove food and grease residues.

Use a degreasing product suitable for stainless steel, a spray-on product for instance, which can reach all parts of the equipment, especially the back of the suction conveyor.

Clean the fans frequently for proper operation and to avoid abnormal mechanical stress due to grease residues on the blades.

Do not use direct jets of water. These operations must be performed by qualified personnel.

#### **WARNING:**

- Under no circumstances should you use abrasive or corrosive cleaning products.
- It is absolutely forbidden to use scrapers, metal soap pads and other common steel tools as they could besides scratching the surface, deposit iron particles that, oxidizing would cause rust to form.
- Bleach, hydrochloric acid and other compounds containing chlorine will damage the stainless steel.
- When cleaning, do not wash the appliance with jets of water.
- It is forbidden to remove the safety guards.
- Smoking is prohibited.

### **1.11 Unplanned maintenance**

Before carrying out any maintenance operation, put the appliance in a safe condition. Unplanned maintenance is carried out in the event of a fault or malfunction. It must only be performed by qualified personnel and with the appliance disconnected from the power or water mains. In this case, repairs or replacements might be required. The faulty parts must only be replaced with materials and components that are identical to the originals or have been specified by the Supplier. The use of unsuitable materials can make the machine non-compliant with the safety standards. The manufacturer declines all responsibility for damage resulting from work carried out by unqualified or unauthorised technicians.

If the user replaces components or modifies the appliance without written permission from the Manufacturer, or uses unauthorised spare parts, the guarantee will immediately become null and void.

### **1.12 Disposal**

At the end of its service life, the appliance must be disconnected from the power mains before the various components are disassembled. Special care must be taken to avoid the risk of injury related to the shape and weight of each component.

This appliance is marked according to the European directive 2012/19/UE on Waste Electrical and Electronic Equipment (WEEE).



The symbol on the product indicates that it should not be considered as domestic waste. The appliance must be disposed of in accordance with the laws in force, most especially in regards to the disposal of the refrigerant. The various parts (electrical components, rubber hoses, cable sheaths, etc.) must be sorted for recycling in order to make the best possible contribution whilst protecting the environment and complying with the laws in force.

## 2. INTRODUCTION

Read this manual carefully before commencing installation.

The manual has been designed to provide the user with all the information required to use the appliance safely, from its transportation right through to its disposal. In order to properly understand the document, you must be familiar with the terms and symbols used; these are summarised below:



WARNING – Health and safety hazard for the persons involved



WARNING - Electrical hazard - Dangerous voltage



Read the instruction manual before using the appliance.

The manual must be stored carefully so that it can be used for future reference. If the appliance changes hands, the manual must also be handed over to the new user.

This documentation is also made available by the manufacturer in digital format.

In order to use the appliance correctly:

- Do not remove or tamper with the safety devices;
- It is prohibited to perform any checks, cleaning operations or maintenance works on moving parts;
- Only use the appliance for the purposes for which it was specifically designed;
- Keep unauthorised personnel away from the appliance;
- It is prohibited for people under the age of 18 or adults with limited physical or mental abilities to use the appliance;
- Have maintenance performed exclusively by qualified personnel;
- Switch off the appliance in the event of a fault or malfunction;
- Disconnect the equipment when cleaning the machinery;
- Only use the spare parts supplied or indicated by the Manufacturer;
- Ensure the oven is on a stable position and safety devices installed upstream are efficient;
- Always use adequate protection gloves to introduce or pull out the trays;
- Periodically have a check with technical service and replace eventual damaged parts, that could alter the proper functioning of the oven or be a danger;
- Often clean the oven following the instructions stated in this manual;
- Don't put trays or other kitchen tools on the oven;
- In order to avoid burns, never use trays or containers with liquids or fluids over a level that can be easily controlled at sight;
- Always pay maximum attention to the floor, that due to cooking steam could be slippery;
- Ensure proper lighting and ventilation according to legal regulations.



Attention: only qualified personnel are authorised to access the main control board and any other electrical parts, whether for installation or maintenance purposes.

The Manufacturer declines all responsibility for damage to property or bodily injury caused by the failure to follow the instructions and warnings contained in the manual.

If in any doubt, and whenever the need arises, contact the Dealer.

## 3. APPLIANCE DESCRIPTION

Our electric convection, convection with manual humidification and combi ovens are made of AISI 430 and/or 304 stainless steel with sealed cooking chamber and rounded corners for better cleaning and hygiene.

They are equipped with a flap or flag door, the latter with a folding glass on hinges for easy cleaning. The maximum operating temperature is 270°C. The control panel on the front is analogue or digital depending on the models.

Some models are also equipped with:

- autoreverse system that allows the fan(s) to automatically change rotation for better uniformity in heat distribution
- drain for water resulting from internal moisture and cleaning operations
- upper internal heating element for Grill mode

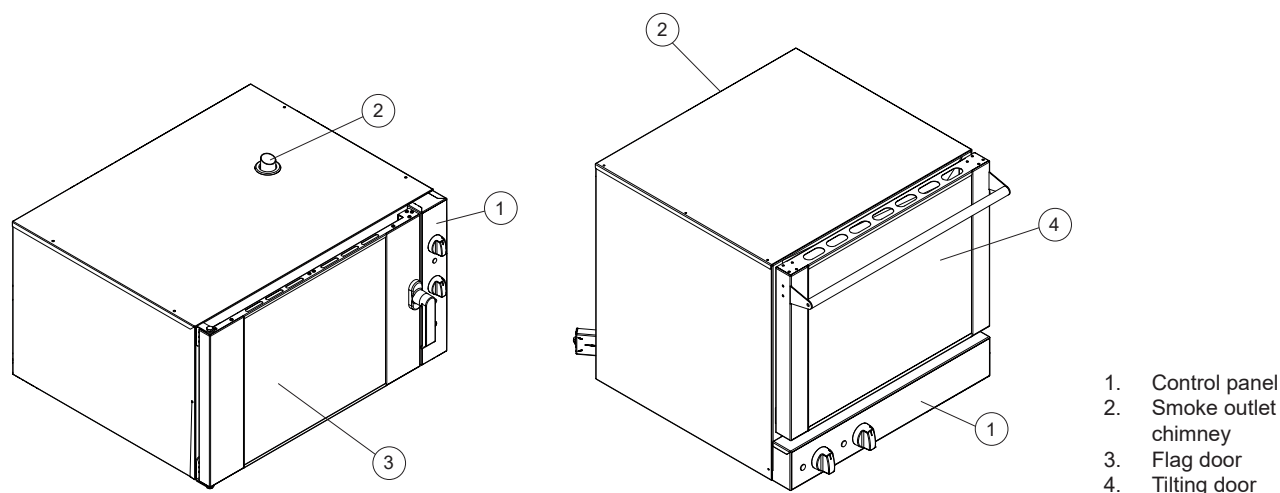

The equipment complies with Directives 2014/35/UE, 2014/30/UE and 1935/2004/CE.

In addition, the following standards have also been applied: EN 60335-1, EN 60335-2-36, EN 61000-3-2, EN 61000-3-3, EN 55014.1 ed EN 55014.2

The sound pressure level is less than 70 dB.

## 4. TRANSPORTATION AND HANDLING

 If the appliance is transported on a pallet, it must be unloaded by trained personnel using a forklift or other suitable lifting equipment. During loading and unloading operations, it is prohibited to stand under suspended loads. Any manoeuvring errors could cause crushing injuries.

Any blows to the surfaces of the appliance could result in immediate damage.

During this phase, anyone not directly involved in the operation must not be allowed to remain in the area.

The personnel handling, positioning, assembling or disassembling the appliance, must be qualified and wearing suitable personal protective equipment (e.g. work gloves, safety shoes).

## 5. OPERATING CONDITIONS AND TECHNICAL SPECIFICATIONS

The equipment covered by this manual is designed solely for cooking food and the regeneration of precooked and/or refrigerated food. Any other use shall be considered improper.

 Warning: the appliances are not suitable for outdoor installations and/or environments subjected to the weather (rain, direct sunlight, etc.).  
Warning: do not store explosive substances such as pressurised containers or items containing a flammable propellant inside these appliances.

 Warning: in order to avoid burns, never use trays or containers with liquids or fluids over a level that can be easily controlled at sight.

### 5.1 Rating plates

On each oven there are applied some rating plates, that give important info concerning characteristics of the oven, electric and plumbing connections and eventually the drain connection.

The following rating plate (A) contains the product's identification and technical data. The information it contains is listed below:

			CE		1			
MOD.	2		N°	3				
V	4	5	6	A	7	Hz	8	kW max
								

- Manufacturer
  - Conformity to EC directives
1. Appliance's year of manufacture
  2. Item Model
  3. Serial number
  4. Electrical data: supply voltage (V)
  5. Electrical data: number of phases (~),
  6. Electrical data: absorbed current (A)
  7. Electrical data: supply frequency (Hz)
  8. Electrical data: maximum absorbed power (kW)

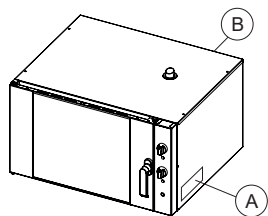

The main plate A is applied on the right side of the oven.

If the oven is equipped with humidification, in the back of the oven, near the connector for water connection there is the label B, which contains the water features required for proper oven operation.

 Warning: before installing the appliance, make sure that the electrical connection preparations comply with the information indicated on the rating plate. It is prohibited to remove or modify the rating plate or any other warning label.

8

## 5.2 Analogue controls

The control devices are grouped together on the instrument panel illustrated in Fig. 1. Electrical components conform to standards.

Fig. 1

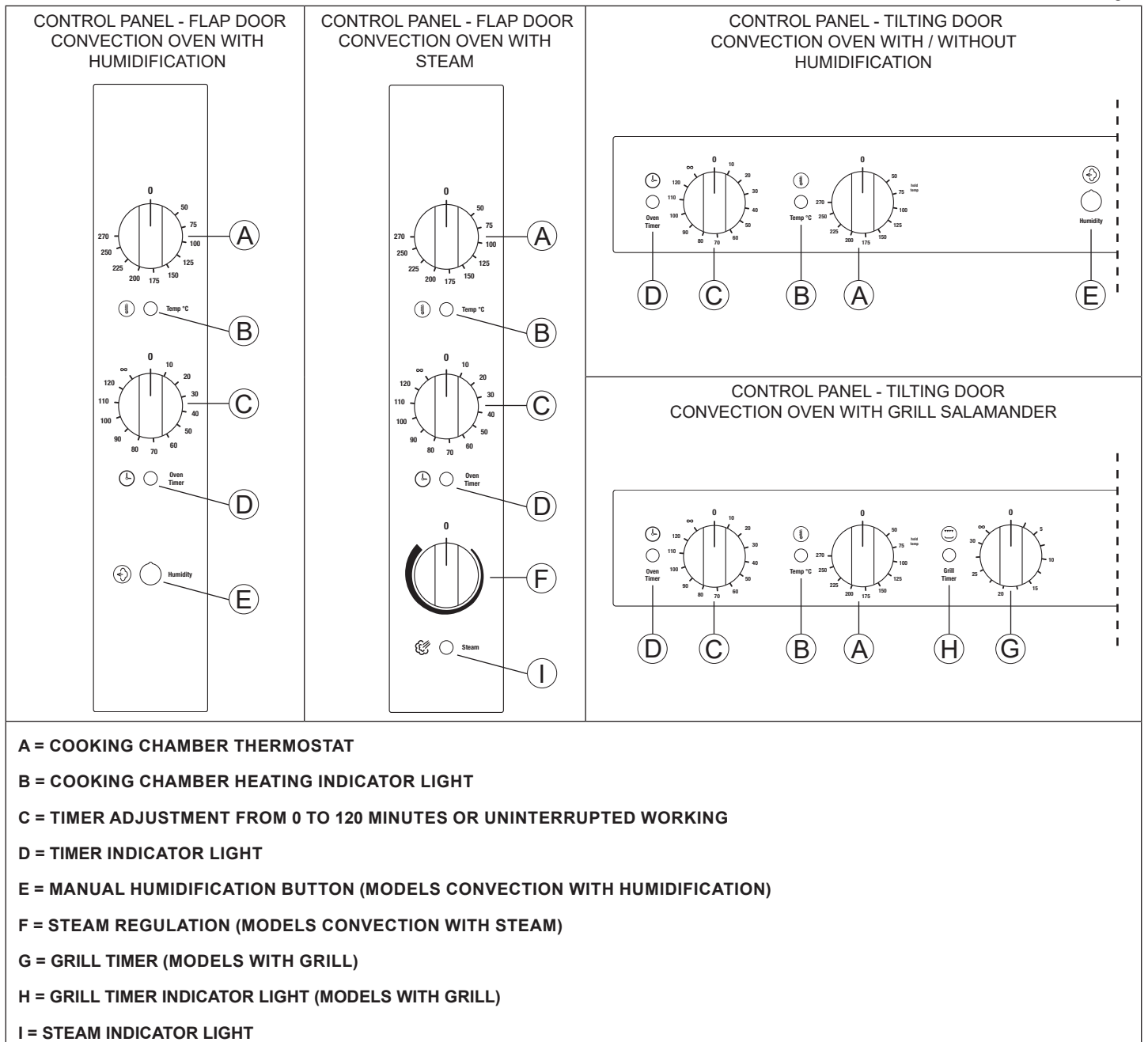

## 5.3 Digital controls

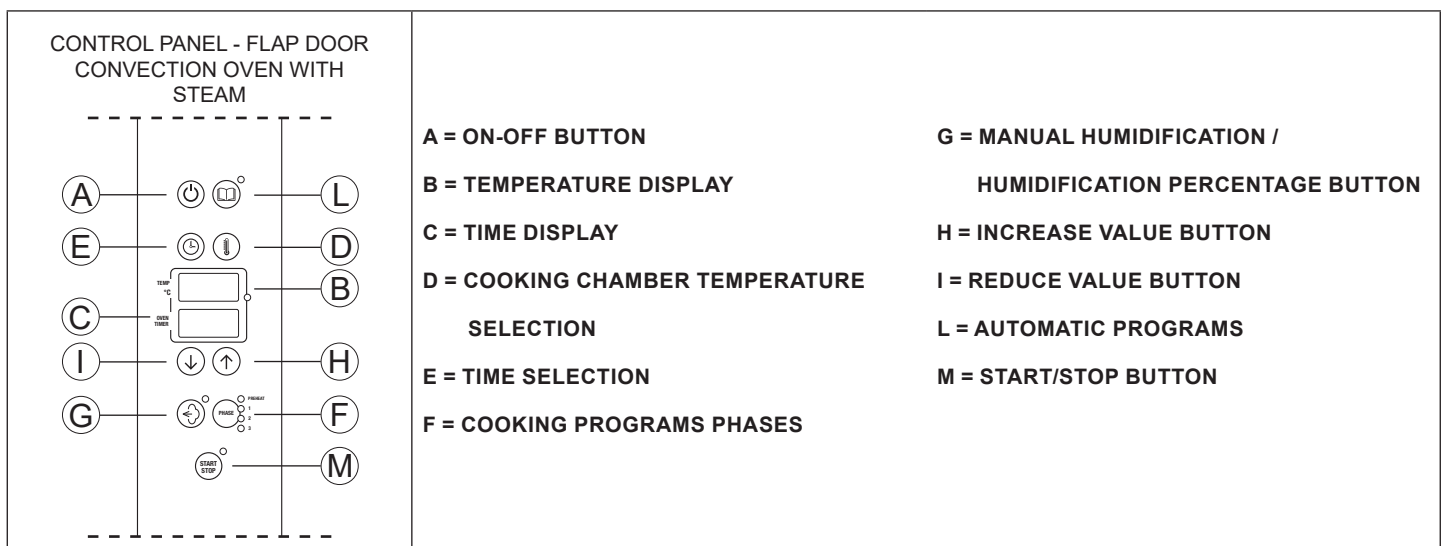

## 6. INSTALLATION

### 6.1 Controlling the appliance upon receipt

Before unpacking the appliance, check that the outer protective casing is fully intact.

Any damage must be promptly reported to the courier. In any case, no damaged appliance can be returned to the manufacturer without prior notice and without prior written authorisation.

### 6.2 Positioning



The described operations must be carried out by qualified personnel. Before performing any installation procedure, disconnect the appliance from the power mains.

Set down the appliance where desired using a pallet truck. If the unit is moved after it has been unpacked, protect the surfaces from knocks. Once the installation has been carried out, the protective film can be removed. This operation should be performed very slowly to prevent the glue from remaining on the surfaces. Take the protective film off by hand before starting the appliance without using abrasive substances and/or metal objects.

### 6.3 Preparations to be made by the client

Use an earthed socket with an adequate capacity for the absorption indicated on the rating plate.

Before installing the appliance, check the load-bearing capacity and flatness of the surface on which it is to be placed. Incorrect levelling can cause the appliance to malfunction.

### 6.4 Electrical connections



They must be carried out in accordance with the local regulations in force. Before performing the electrical connection, make sure that the voltage and frequency correspond to the information indicated on the appliance's rating plate. The electrical connection is carried out by connecting the appliance's plug to a socket in the room; this socket must still remain accessible after the installation.

If the purchased oven does not have a power cable, the electrical connection must be made by qualified personnel by connecting the cable to the terminal board.

The distance between the oven and the socket must be such that the power cable is not stretched. Furthermore, the cable must not be located under the base of the oven.

Use cable type H07RNF or equivalent and an efficient and correctly sized earth conductor according to the total power of this appliance (see rating plate).

If the power cable is damaged, it must be replaced by the customer service or qualified personnel.

The appliance's electrical supply system must be equipped upstream with an appropriately-sized automatic omnipolar circuit breaker that ensures a gap of at least 3 mm between the contacts. There must not be any breaks in the earth cable.



The electrical safety of this appliance is only guaranteed when the above-mentioned conditions are met and if the system's equipotential situation is also compliant (use the connection screw located near the power cable input and the symbol sticker  $\perp$ ).



Any operations carried out on electrical systems must be performed by qualified personnel.

The manufacturer declines all responsibility in the event that these safety standards are not complied with.

### 6.5 Hydraulic connections

If the humidification system is installed (optional), the ovens have a water inlet coupling at the back. Always install an on-off valve between the appliance and the water mains, making sure it is easy to operate. We also suggest installing a cartridge filter on the water inlet pipe.

Always use a set of new water joints, eventual old joints must not be used again.

Plumbing connection must always be made with cold water and executed with rigid pipes

Never use hoses to connect the oven to the water main.

The water must be suitable to human use with the following characteristics:

DESCRIPTION	VALUES	NOTES
Temperature	included between 15 - 20 °C	
Total hardness	included between 4 and 12 °f (French degrees)	It is advisable to install a softener upstream of the appliance to keep the water hardness within these values. Higher values lead to limescale build-up in the oven cooking chamber.
Pressure	included between 150 and 250 KPa (1,5 - 2,5 bar)	Higher water pressure values result in increased water consumption and can compromise the correct functioning of some components.
Maximum chloride concentration(Cl <sup>-</sup> )	less than 150 mg/litre	
Chlorine concentration (Cl <sub>2</sub> )	less than 0.2 mg/litre	
pH	more than 7	
Water conductivity:	included between 50 and 2000 µS/cm	

## 7. OPERATION/USE

### 7.1 Intended use and restrictions

- The equipment covered by this manual is designed solely for cooking food and the regeneration of precooked and/or refrigerated food. Any other use shall be considered improper.
- The machines have not been designed for use in unsupervised environments. Furthermore, the appliances are not suitable for outdoor installations and/or environments subjected to the weather (rain, direct sunlight, etc.).
- Do not store explosive substances such as pressurised containers or items containing a flammable propellant.

### 7.2 Switching on the oven for the first time

At the first use of the equipment it is recommended to clean the steel parts with a neutral detergent and a damp cloth.

Make sure that the machine is in a large and well ventilated environment.











Then turn on the oven and leave it running for at least 1 hour before the first batch. Do not cook any food during this phase.







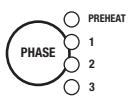

The possible presence of fumes or bad odours at this stage is due to the evaporation of the processing residues of the internal components.

### 7.3 Start up and shutdown phases

- Switch on the protection switch located upstream of the equipment and the water shutoff valve if the oven is equipped with manual humidification.
- Select the cooking time with the timer (C)
- When the timer is on and the door is closed the cooking cycle starts together with the electric fan, heating and steam generation, if selected.
- For longer cooking times, select the (∞) nonstop position.
- When the set time is finished a buzzer signals that cooking is finished and all the functions stop.
- When selecting the cooking time always remember the time needed to pre-heat the oven.
- The oven is switched off by turning the timer knob to position 0 in analogue controls, or by pressing the A On/Off button in case of digital controls.

### 7.4 Digital thermostat operation

Button	Function
<b>STARTING THE OVEN</b>	
	Press ON/OFF button to turn on the display. ATTENTION! Switching off the oven with ON/OFF button does not interrupt the power supply to the electronic boards. If the oven is not used, we advise you to switch off electric power supply using the protection switch upstream.
<b>COOKING CHAMBER TEMPERATURE</b>	
	Display B shows the temperature of the cooking chamber. Pressing temperature button (D), the display starts flashing and shows the values set.
	Press the button shown on the side to increase the value on the display.
	Press the button on the side to reduce the value on the display. Press again temperature button (D) to store the new value for the cooking. The led stops flashing. The temperature range of the cooking chamber is 30 - 270 °C.
<b>COOKING TIME</b>	
	Press button E on the side to change cooking time. Display C shows ---.
	Press the button on the side to increase the value on the display.
	Press the button on the side to reduce the value on the display. For an unlimited functioning of the oven (infinite time), press the button on the side, when the display shows value 0. The display will then show ---.
<b>HUMIDIFICATION PERCENTAGE</b>	
	Press the button on the side to change humidification percentage.
	Press the button on the side to increase the value on the display.
	Press the button on the side to reduce the value on the display. Press again humidification button to switch off the flashing led and store the new value for the cooking. The humidity percentage range is: 0% - 20% - 40% - 60% - 80% - 100%

<b>ADDING COOKING PHASES</b>	
	<p>When a cooking parameter is confirmed, led 1 next to phases button F, flashes for some seconds. During this time it is possible to add a cooking phase, pressing button F. You can set 3 phases maximum.</p>
<b>STARTING A MANUAL COOKING</b>	
	<p>Pressing button M (Start/Stop) the preheating phase starts. The lower display shows the word PrE. The leds PREHEAT next to PHASE button and the led next to START/STOP button turn on.</p> <p>When set preheating temperature is reached, the buzzer starts ringing to advise the end of the preheating. On the lower display the writing "PrE" flashes together with the preheating led. The oven will maintain the preheating temperature until the door is opened to load the food. When the door is closed, the cooking starts with phase 1.</p> <p>If the door is opened during preheating (before reaching the set preheating temperature), preheating is automatically interrupted, as it is presumed the food has been loaded into the oven. During preheating it is not possible to use automatic humidification, whereas manual humidification is available.</p>
<b>MANUAL HUMIDIFICATION</b>	
	<p>Manual humidification can be activated while cooking by pressing button G. The valve that injects steam in the cooking chamber is activated only when button G is pressed. It is possible to change the parameters during the cooking in order to adapt it to the food.</p>
<b>AUTOMATIC COOKING PROGRAMS</b>	
	<p>You can store up to 99 programs, from P01 – to P99. There are 3 phases for each program. 3 leds indicate the working phase (or the phase that is being set). For each phase can be set:</p> <ul style="list-style-type: none"> <li>• Temperature</li> <li>• Time</li> <li>• Humidification</li> </ul> <p>The oven is supplied with preset but not configured programs. To search a program, select the programs list (not during a cooking) with button L (pressing it slightly).</p> <p>The led next to button L is flashing, the upper display is turned off and the lower shows the name of the program (P01...P99). Using the buttons with arrows you can go up and down the list. To confirm the chosen program, press again button L. The display shows the standard screen, the led next to button L is on and the lower display shows the number of the selected program. The cooking parameters of each phase can be changed. Pressing Start, the preheating of the selected program starts.</p>
<b>STORING A PROGRAM</b>	
	<p>To store a program after selecting and modifying it, press button L for 5 seconds with the number of the program shown on the display. The storing is confirmed by program leds flashing for some seconds. If the display shows phases settings, you need to press L to change view and then again for 5 seconds to store the program.</p>
<b>DELETING A PROGRAM</b>	
	<p>To delete a program when it is shown in the programs list, press for long and simultaneously buttons E and D. The deleted program becomes empty (not written) and it is stored.</p>
<b>QUITTING AUTOMATIC PROGRAMS</b>	
	<p>To go back to manual cooking, press ON/OFF.</p>
<b>SWITCHING OFF THE OVEN</b>	
	<p>To switch off the oven, press ON/OFF for some seconds (until the display turns off).</p>

## 7.5 Total shutdown

When the unit is to be decommissioned for a lengthy period, the following measures must be taken:

- Turn the main switch off;
- Close the water on-off valve (if the oven is connected to the water supply);
- Leave the door open so air can circulate and prevent bad odors;
- With a cloth spread a thin protective layer of Vaseline oil on all stainless steel surfaces;

## 7.6 Remedies to cooking hitches

If cooking is uneven check that:

- there is at least 3 cm between the food cooking and the tray above it;
- the food to be cooked has not been stacked against each other, preventing proper ventilation between products;
- the cooking temperature is correct and not too high.

If the food is dry:

- the cooking time should be reduced and the temperature lowered appropriately
- the food was not greased with oil or juices before it was put in to cook.

## 8. CLEANING AND MAINTENANCE

### 8.1 Routine maintenance

The cleaning operation must be carried out only after disconnecting the power supply upstream of the appliance and checking that the oven is cold. During the operation the cable and the plug must be brought in position always visible by the operator who is performing the intervention. Routine and preventive maintenance consists essentially of weekly cleaning of stainless steel parts with a damp cloth and a neutral non-corrosive soap, followed by careful drying.

The oven cooking chamber must be cleaned at the end of each cooking process to remove food and grease residues.

Use a degreasing product suitable for stainless steel, a spray-on product for instance, which can reach all parts of the equipment, especially the back of the suction conveyor.

Clean the fans frequently for proper operation and to avoid abnormal mechanical stress due to grease residues on the blades.

Do not use direct jets of water. These operations must be performed by qualified personnel.

#### WARNING:

- Under no circumstances should you use abrasive or corrosive cleaning products
- It is absolutely forbidden to use scrapers, metal soap pads and other common steel tools as they could besides scratching the surface, deposit iron particles that, oxidizing would cause rust to form
- Bleach, hydrochloric acid and other compounds containing chlorine will damage the stainless steel
- When cleaning, do not wash the appliance with jets of water
- It is forbidden to remove the safety guards
- Smoking is prohibited

### 8.2 Unplanned maintenance

Before carrying out any maintenance operation, put the appliance in a safe condition. Unplanned maintenance is carried out in the event of a fault or malfunction. It must only be performed by qualified personnel and with the appliance disconnected from the power or water mains. In this case, repairs or replacements might be required. The faulty parts must only be replaced with materials and components that are identical to the originals or have been specified by the Supplier. The use of unsuitable materials can make the machine non-compliant with the safety standards. The manufacturer declines all responsibility for damage resulting from work carried out by unqualified or unauthorised technicians.

If the user replaces components or modifies the appliance without written permission from the Manufacturer, or uses unauthorised spare parts, the guarantee will immediately become null and void.

## 9. DISPOSAL

At the end of its service life, the appliance must be disconnected from the power mains before the various components are disassembled. Special care must be taken to avoid the risk of injury related to the shape and weight of each component.

This appliance is marked according to the European directive 2012/19/UE on Waste Electrical and Electronic Equipment (WEEE).



The symbol on the product indicates that it should not be considered as domestic waste. The appliance must be disposed of in accordance with the laws in force, most especially in regards to the disposal of the refrigerant. The various parts (electrical components, rubber hoses, cable sheaths, etc.) must be sorted for recycling in order to make the best possible contribution whilst protecting the environment and complying with the laws in force.

## 10. ATTACHED DOCUMENTATION

- Test sheet
- Wiring diagram



# 11. SPECIFICHE TECNICHE - TECHNICAL FEATURES - TECHNISCHE SPEZIFIKATIONEN - SPÉCIFICATIONS TECHNIQUES

## 11.1 Forno analogico con porta a bandiera - Analog oven with flag door - Analoger Backofen mit Flügeltür - Four analogique à porte battante

Caratteristiche tecniche – Technical features - Technische Merkmale - Caracteristiques techniques

4 x GN 2/3  
4 x 460x340

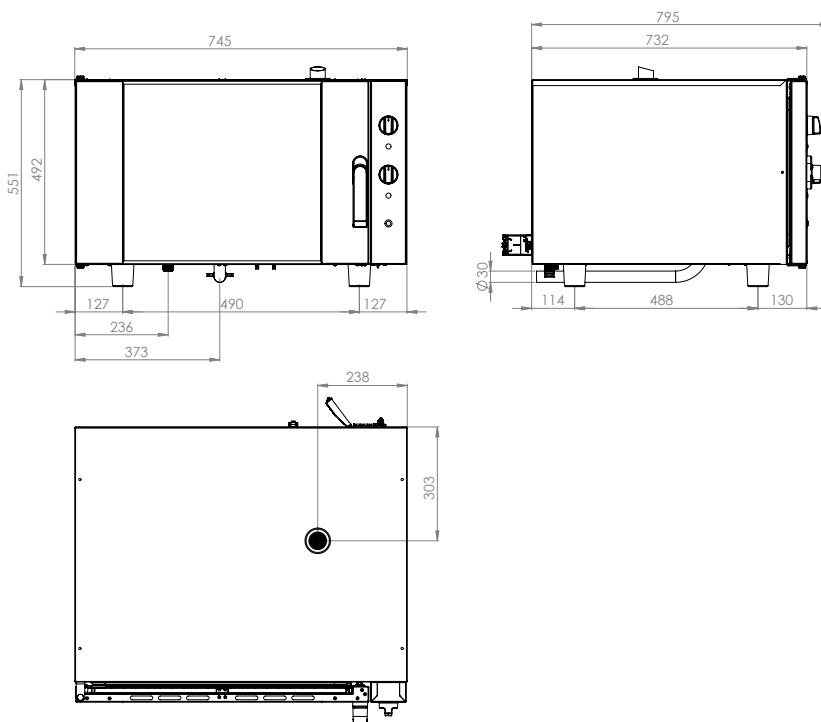

4 x GN 1/1  
4 x 600x400

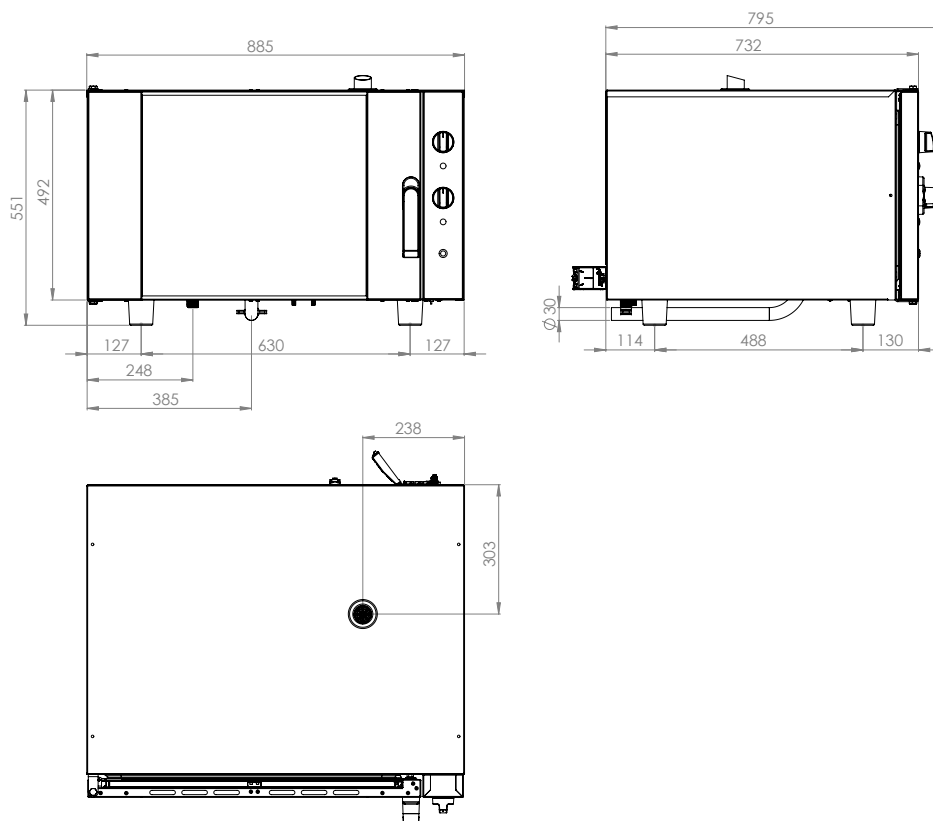

**6 x GN 1/1**

**6 x 600x400**

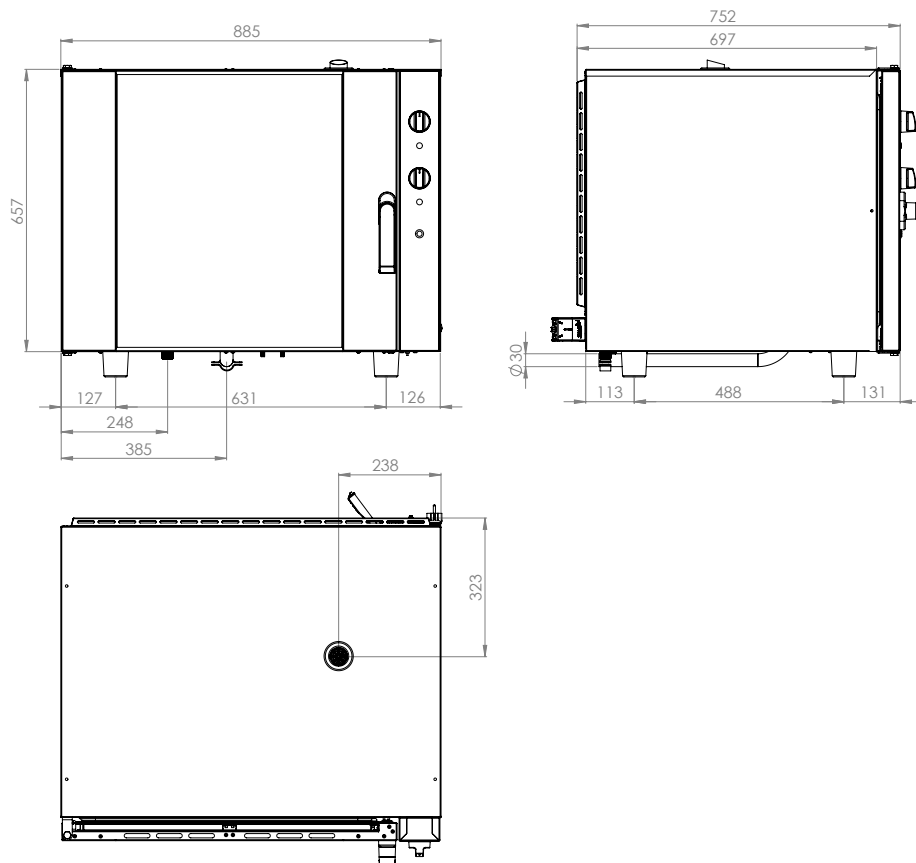

**Tab. A**

<b>Capacità/Numero teglie</b> <i>Capacity/Number of trays, Kapazität/Anzahl der Backformen, Capacité/Nombre de bacs</i>	<b>4 x GN 2/3</b>	<b>4 x 460x340</b>	<b>4 x GN 1/1</b>	<b>4 x 600x400</b>	<b>6 x GN 1/1</b>	<b>6 x 600x400</b>
<b>Dimensioni esterne [mm] LxPxH</b> <i>External dimensions, Außenmaße, Dimensions extérieures</i>	745x795x560	745x795x560	885x795x560	885x795x560	885x815x720	885x815x720
<b>Dimensioni camera [mm] LxPxH</b> <i>Chamber dimensions, Raumgröße, Taille de la chambre</i>	520x440x380	520x440x380	660x440x380	660x440x380	660x450x520	660x450x520
<b>Distanza teglie [mm]</b> <i>Trays distance, Einschubabstand, Encartement grilles</i>	75	75	75	75	75	75
<b>Peso a vuoto [Kg]</b> <i>Empty weight, Leergewicht, Poids à vide</i>	52	52	65	65	83	83
<b>Temperatura massima [°C]</b> <i>Max. temperature, Max. temperature, Température max</i>	270	270	270	270	270	270
<b>Numero e potenza motori</b> <i>No. and motor power, Anz. und Motorleistung, N° et puissance moteur</i>	1x 120 W	1x 120 W	2x 120 W	2x 120 W	2x 120 W	2x 120 W
<b>Potenza riscaldante [KW]</b> <i>Heating power, Heizleistung, Puissance de chauffe</i>	3	3	6	6	7,4	7,4
<b>Tensione alimentazione [50Hz]</b> <i>Supply voltage, Versorgungsspannung, Tension d'alimentation</i>	230V 1F+N	230V 1F+N	400V 3F+N	400V 3F+N	400V 3F+N	400V 3F+N
<b>Potenza Tot. [KW]</b> <i>Total power, Leistungsaufnahme, Puissance totale</i>	3,3	3,3	6,2	6,2	7,9	7,9
<b>Cavo elettrico in dotazione</b> <i>Electric cable supplied, Elektrokabel geliefert, Câble électrique fourni</i>	•	•	-	-	-	-
<b>Sistema Autoreverse</b> <i>Autoreverse system, Autoreverse-System, Système Autoreverse</i>	•	•	•	•	•	•
<b>Umidificazione</b> <i>Humidification, Befeuchtung, Humidification</i>	•	•	•	•	•	•
<b>Diametro entrata acqua</b> <i>Diameter water inlet, Durchmesser Wasserzulauf, Diamètre entrée d'eau</i>	3/4"	3/4"	3/4"	3/4"	3/4"	3/4"

## 11.2 Forno combinato, analogico e digitale, con porta a bandiera - Analog and digital combi-oven with flag door - Analoger und digitaler Kombiofen mit Flügeltür - Four mixte, analogique et numérique, à porte battante

Caratteristiche tecniche – Technical features - Technische Merkmale - Caracteristiques techniques

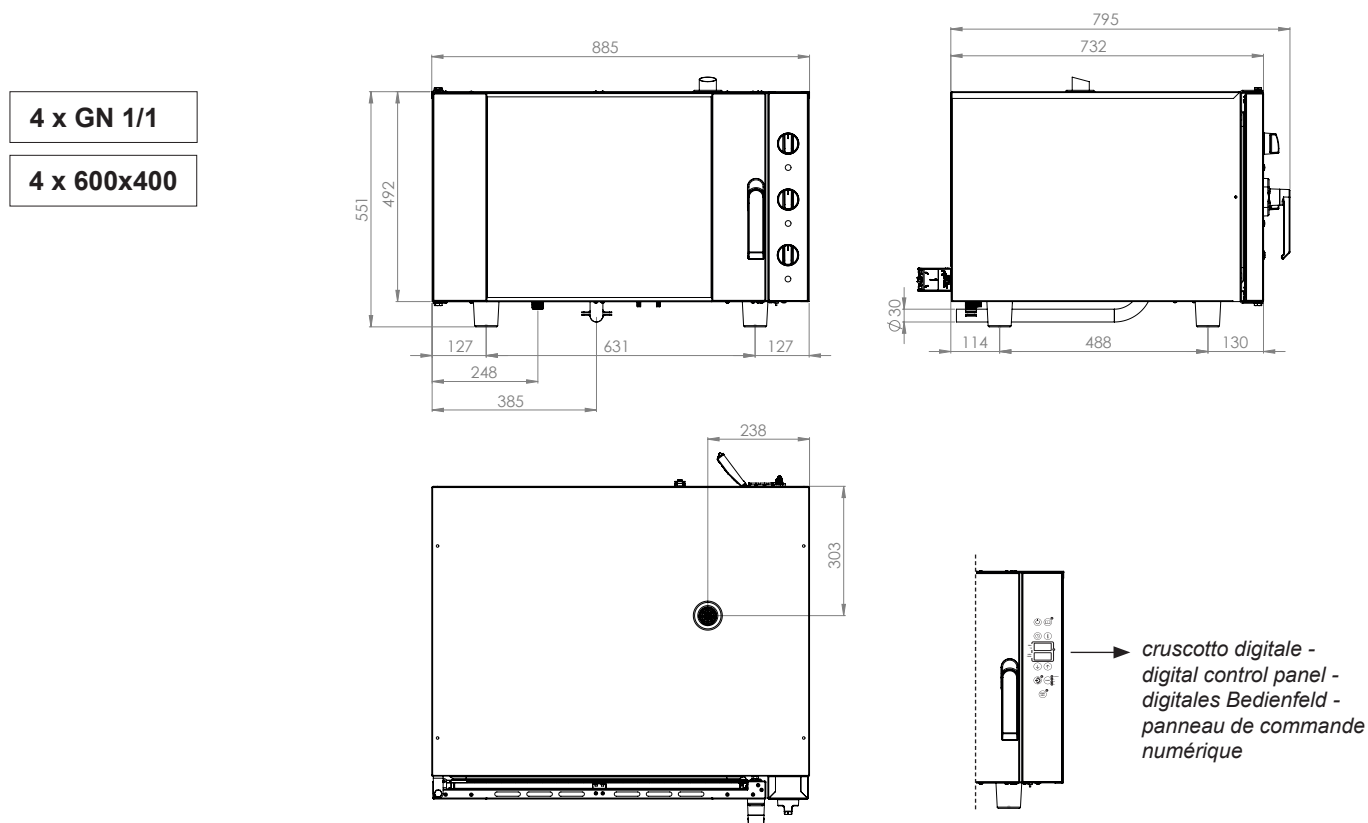

Tab. B

Capacità/Numero teglie Capacity/Number of trays, Kapazität/Anzahl der Backformen, Capacité/Nombre de bacs	4 x GN 1/1	4 x 600x400
<b>Dimensioni esterne [mm] LxPxH</b> External dimensions, Außenmaße, Dimensions extérieures	885x795x560	885x795x560
<b>Dimensioni camera [mm] LxPxH</b> Chamber dimensions, Raumgröße, Taille de la chambre	660x440x380	660x440x380
<b>Distanza teglie [mm]</b> Trays distance, Einschubabstand, Encartement grilles	75	75
<b>Peso a vuoto [Kg]</b> Empty weight, Leergewicht, Poids à vide	65	65
<b>Temperatura massima [°C]</b> Max. temperature, Max. temperature, Température max	270	270
<b>Numero e potenza motori</b> No. and motor power, Anz. und Motorleistung, N° et puissance moteur	2x 120 W	2x 120 W
<b>Potenza riscaldante [KW]</b> Heating power, Heizleistung, Puissance de chauffe	6	6
<b>Tensione alimentazione [50Hz]</b> Supply voltage, Versorgungsspannung, Tension d'alimentation	400V 3F+N	400V 3F+N
<b>Potenza Tot. [KW]</b> Total power, Leistungsaufnahme, Puissance totale	6,2	6,2
<b>Cavo elettrico in dotazione</b> Electric cable supplied, Elektrokabel geliefert, Câble électrique fourni	-	-
<b>Sistema Autoreverse</b> Autoreverse system, Autoreverse-System, Système Autoreverse	•	•
<b>Umidificazione</b> Humidification, Befeuchtung, Humidification	•	•
<b>Diametro entrata acqua</b> Diameter water inlet, Durchmesser Wasserzulauf, Diamètre entrée d'eau	3/4"	3/4"

# 11.3 Forno analogico con porta a ribalta - Analog oven with tilting door - Analoger Backofen mit Kippbare Tür - Four analogique à porte basculante

Caratteristiche tecniche – Technical features - Technische Merkmale - Caracteristiques techniques

4 x GN 2/3

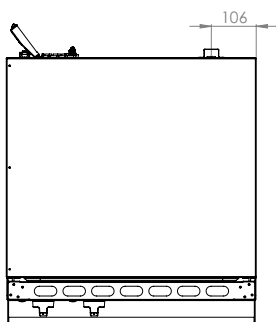
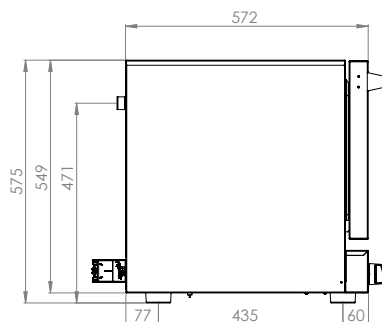
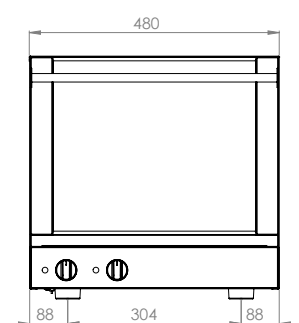

4 x 460x340

4 x 460x340\*

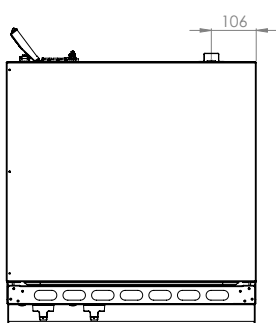
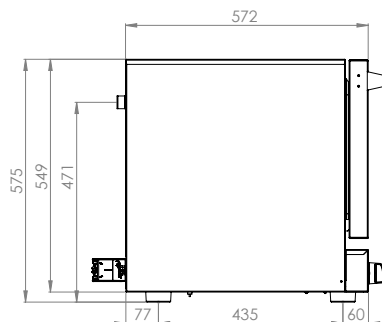
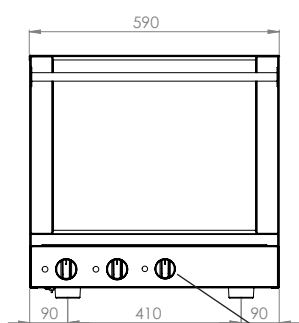

\* per modelli con salamandra - for models with grill salamander - für Modelle mit Grillsalamander - pour les modèles avec salamandre

\* modello con salamandra - model with grill salamander - Modell mit Grillsalamander - modèle avec salamandre

4 x 600x400

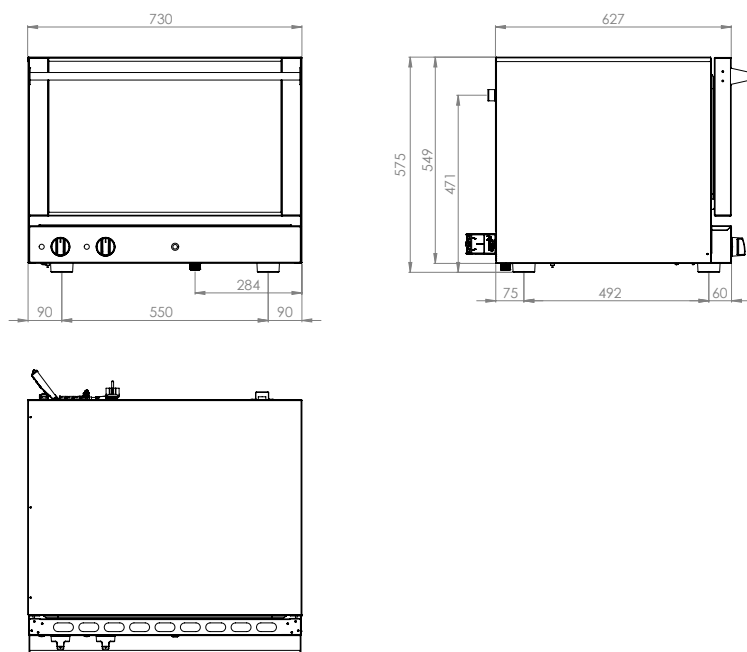

Tab. C

Capacità/Numero teglie Capacity/Number of trays, Kapazität/Anzahl der Backformen, Capacité/Nombre de bacs	4 x GN 2/3	4 x 460x340	4 x 460x340 *	4 x 600x400
<b>Dimensioni esterne [mm] LxPxH</b> External dimensions, Außenmaße, Dimensions extérieures	480x605x575	590x650x575	590x650x575	730x700x575
<b>Dimensioni camera [mm] LxPxH</b> Chamber dimensions, Raumgröße, Taille de la chambre	370x340x325	480x385x330	480x385x330	620x435x330
<b>Distanza teglie [mm]</b> Trays distance, Einschubabstand, Encartement grilles	70	70	70	70
<b>Peso a vuoto [Kg]</b> Empty weight, Leergewicht, Poids à vide	41	41	41	50
<b>Temperatura massima [°C]</b> Max. temperature, Max. temperature, Température max	270	270	270	270
<b>Numero e potenza motori</b> No. and motor power, Anz. und Motorleistung, N° et puissance moteur	2x 55 W	2x 55 W	2x 55 W	2x 55 W
<b>Potenza riscaldante [KW]</b> Heating power, Heizleistung, Puissance de chauffe	2,7	3,2	3,2	3,2
<b>Tensione alimentazione [50Hz]</b> Supply voltage, Versorgungsspannung, Tension d'alimentation	230V 1F+N	230V 1F+N	230V 1F+N	230V 1F+N
<b>Potenza grill [KW]</b> Grill power, Grilleistung, Puissance du gril	-	-	0,7	-
<b>Potenza Tot. [KW]</b> Total power, Leistungsaufnahme, Puissance totale	2,7	3,3	3,3	3,3
<b>Cavo elettrico in dotazione</b> Electric cable supplied, Elektrokabel geliefert, Câble électrique fourni	•	•	•	•
<b>Sistema Autoreverse</b> Autoreverse system, Autoreverse-System, Système Autoreverse	-	-	-	-
<b>Umidificazione</b> Humidification, Befeuchtung, Humidification	-	-	-	•
<b>Diametro entrata acqua</b> Diameter water inlet, Durchmesser Wasserzulauf, Diamètre entrée d'eau	-	-	-	3/4"

\* modello con salamandra - model with grill salamander - modèle avec salamandre - Modell mit Grillsalamander