

05/2018

Mod: TE147/B

Production code: TFC/147



Diamond
catering equipment

**ARMOIRES CHAUFFANTES
VERWARMDE KASTEN
WARMING CUPBOARDS
VENTILIERTE WÄRMESCHRÄNKE**

TFC/127 - TFC/147
TFC/167 - TFC/187
TFC/207

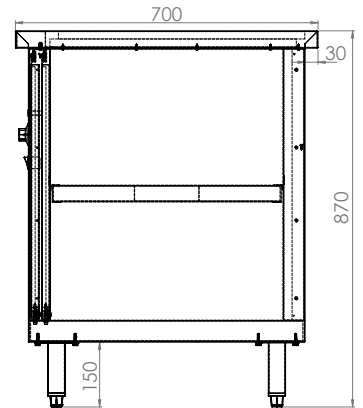
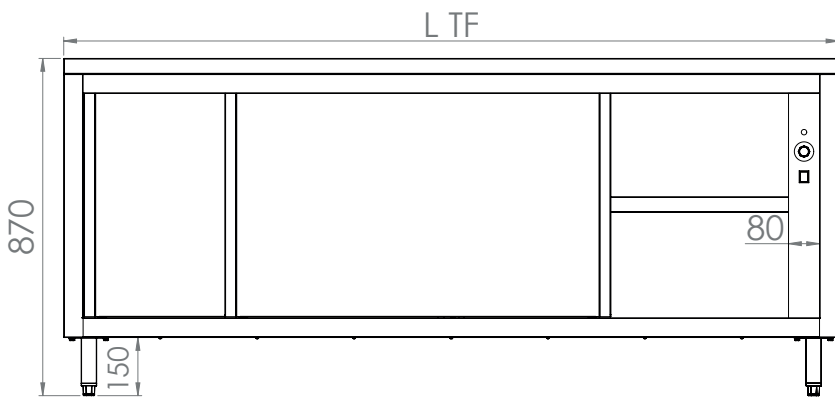

Modèles Modellen Models Modelle	Dimensions Afmeting Dimensions Größe	Bulbe Gloeilamp Bulb Glühbirne	Clicson	Resistance Weerstand Strenght Widerstand	Alimentation électrique Elektrische voeding Electric supply Stromversorgung
	(L X P X H) mm			W	
TFC/127	1200 X 700 X 900	Verticale/Verticaal	150°	2500	230 V 50 Hz
TFC/147	1400 X 700 X 900	Horizontale/Horizontaal	150°	2500	230 V 50 Hz
TFC/167	1600 X 700 X 900	Horizontale/Horizontaal	150°	2500	230 V 50 Hz
TFC/187	1800 X 700 X 900	Horizontale/Horizontaal	150°	2500	230 V 50 Hz
TFC/207	2000 X 700 X 900	Horizontale/Horizontaal	150°	2500	230 V 50 Hz
TFC/127+BAF	1200 X 700 X 900	Verticale/Verticaal	150°	2500	230 V 50 Hz
TFC/147+BAF	1400 X 700 X 900	Horizontale/Horizontaal	150°	2500	230 V 50 Hz
TFC/167+BAF	1600 X 700 X 900	Horizontale/Horizontaal	150°	2500	230 V 50 Hz
TFC/187+BAF	1800 X 700 X 900	Horizontale/Horizontaal	150°	2500	230 V 50 Hz
TFC/207+BAF	2000 X 700 X 900	Horizontale/Horizontaal	150°	2500	230 V 50 Hz