

11/2016

Mod: CTH40-EK

Production code: HTB-40



Diamond
catering equipment



Diamond

catering equipment

HOT TROLLEYS

HOLDING TEMPERATURE TROLLEYS

REFRIGERATED TROLLEYS

**INSULATED TROLLEYS FOR ISOTHERMAL TRAYS
AND GN CONTAINERS**

Your professional partner



From the kitchen to the guest, hot trolleys guarantee that the quality of the food is perfectly maintained due to its superior design and functionality whilst, at the same time, are aesthetically pleasing in all kinds of environments, from catering operations to fine-dining kitchens as well as buffets and serving lines.



- Digital, intuitive control panel, designed with a contemporary sleek design, provides a reliable temperature regulation.
- Moisture Control System, with four (4) relative humidity levels, prevents food from drying out and ensures the best quality for any type of dish since moist air heating optimizes heat transfer to the product. It could also be switched off, when not needed, thus reducing energy consumption.
- Double-skinned walls and doors, with a high-density, CFC-free injected polyurethane insulation, provide robustness and durability and reduce heat losses, obtaining significant energy savings.
- 270 ° opening door system, with robust hinges, offers users maximum freedom of movement and safety, increasing ergonomics and confront in their daily work operations.
- Mono-block stamped guides, with rounded edges, guarantee maximum hygiene and safe operation for employees.
- Internal door surface is completely flat without any elements that make difficult a complete cleaning operation.
- Powerful and efficient convection heating system, made of resistor and fan, allows hot air circulation and even temperature distribution in the interior. Less heat losses
- Gasket fixed to the internal door structure ensures that hot air stays inside the trolley. Gasket is easy to replace, without any tools, enabling effortless maintenance and cleaning operations.
- Stamped water tank with rounded edges, easy to access and refill.
- High-performance silicon resistor allows fast heating.
- All-round bumper rail, manufactured in a non-marking high-resistant material, to protect against direct impacts against walls and furniture.
- Four (4) sound-proof castors of 160 mm diameter, two (2) of them with brakes for an easy handling and safer use.



Control panel protected by two (2) corner elements manufactured in high-resistant material.



Non-protruding and robust push handles located at both sides. Handle diameter and separation to the structure has been ergonomically designed to fit in any hand.



Fast access to functional elements speeds up and makes easier maintenance tasks.



Mono-block stamped guides with a 70 mm separation. Rounded edges guarantee an easy, profound cleaning of interior.

Ref: CTH10-EK



- mm (BxDxH): 790 x 935 x 1215
- Doors: 1
- GN 2/1 rack rails supplied: 10
- Voltage (V): 230/1/50-60Hz
- Power (W): 2000

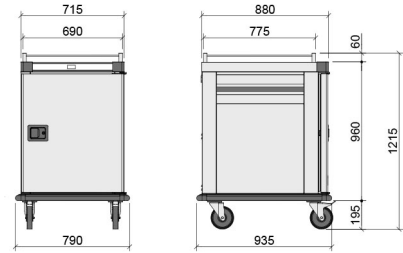

Ref: CTH20-EK



- mm (BxDxH): 790 x 935 x 1855
- Doors: 1
- GN 2/1 rack rails supplied: 20
- Voltage (V): 230/1/50-60Hz
- Power (W): 2000

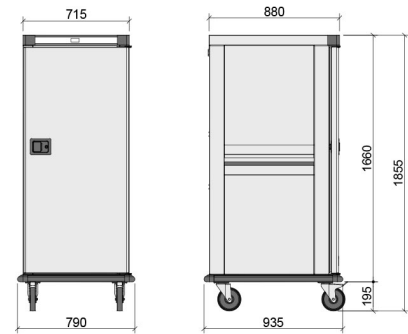

Ref: CTH40-EK



- mm (BxDxH): 1525 x 935 x 1885
- Doors: 2
- GN 2/1 rack rails supplied: 40
- Voltage (V): 230/1/50-60Hz
- Power (W): 3500

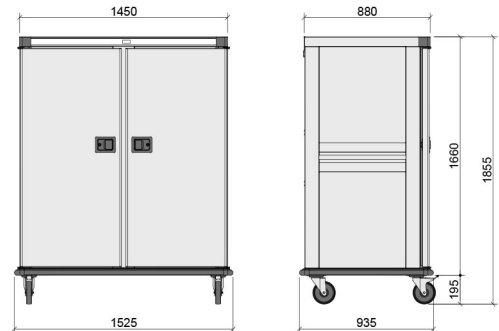

DIGITAL CONTROL PANEL

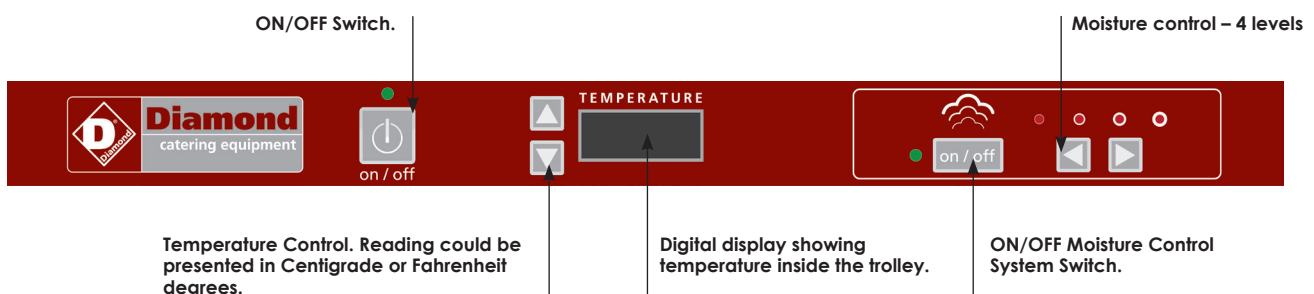



- Especially designed for maintaining and serving previously prepared hot food.
- Food can be hold inside the trolley directly on plates by using of rod shelves or in Gastronorm pans.
- 10, 20 or 40 GN 2/1 rack rails (according to the model) with 60 mm separation between rack rails.
- Doubled wall with an injected CFC-free, ecological polyurethane 40 Kg/m³ density isolation. With its highly-insulated walls, heat losses are reduced thus obtaining energy savings.
- Heating system by using two (2) forced-air electric resistors in each cabinet body to ensure that heat is distributed trough all the unit. The special design of the chamber and rack rails enables the creation of a uniform, even airflow distribution, ensuring that food is always maintained at its right temperature. Waveless evaporation tray system to control humidity in the chamber and prevent food from drying out.
- Thermostat and external thermometer to monitor, control and regulate the temperature at desired setpoint: from 0°to 90°C.
- Horizontal handle system for fast opening and closing of door.



Waveless evaporation tray system to control humidity in the chamber and prevent food from drying out.



CCB-40 models include a central grid system to optimize the space inside the trolley (20 central grids are supplied).

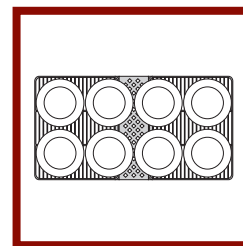

Up to eight (8) plates of a maximum diameter of 300 mm can be stored per level. That makes a total of 160 plates.

Your professional partner

HOLDING TEMPERATURE TROLLEYS

- Automatic locking mechanism in hinges: when door is in a position of less than a 100° angle it gets fully closed, thus avoiding loss of temperature and achieving energy savings.
- Four (4) sound-proof castors of 160 mm diameter, two of them with brakes for an easy handling and safer use.
- Non-marking, special rubber bumpers to protect against direct impacts along the whole trolley base.
- Key locked door.
- Made of stainless steel.
- Rod shelves and Gastronorm pans are not included. To be ordered separately.

Ref: CCE10



- mm (BxDxH): 783 x 860 x 1207
- Doors: 1
- GN 2/1 rack capacity: 10
- Voltage (V): 230/1N 50-60Hz
- Power (W): 2000

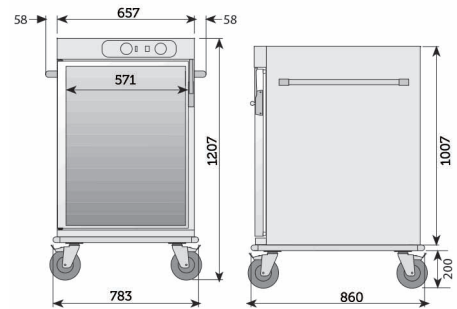

Ref: CCE20



- mm (BxDxH): 783 x 860 x 1640
- Doors: 1
- GN 2/1 rack capacity: 20
- Voltage (V): 230/1N 50-60Hz
- Power (W): 2000

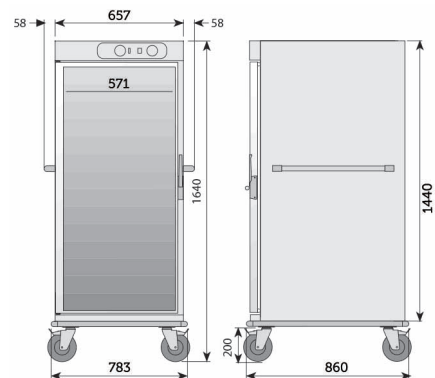

Ref: CCE40



- mm (BxDxH): 1473 x 860 x 1640
- Doors: 2
- GN 2/1 rack capacity: 40
- Voltage (V): 230/1N 50-60Hz
- Power (W): 3600

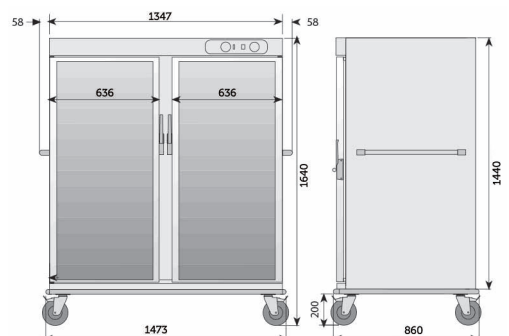



- Especially designed for maintaining and serving previously prepared cold food. Ideal to replace cold chambers or refrigeration units.
- Refrigeration unit with fan built inside the chamber. A constant flow of chilled air is generated by the evaporation fans, leading to a fastest temperature drop, as well as a better, more uniform cool air distribution.
- Digital reading electronic to monitor and control chamber temperature and defrosting cycle.
- Operating temperature ranges from +2° to +8° C with a 32° C room temperature.
- Doubled wall with an injected CFC-free, ecological polyurethane 40 Kg/ density isolation. With its highly-insulated walls, heat transfers are reduced thus obtaining energy savings.
- Automatic locking mechanism in hinges: when door is in a position of less than a 100° angle it gets fully closed, thus avoiding rising of temperature.



Robust push handles located at both sides.



Digital reading electronic to monitor and control chamber temperature and defrosting cycle.



Four (4) sound-proof castors of 125 mm diameter, two of them with brakes for an easy handling and safer use. Non-marking, special rubber bumpers to protect against direct impacts in all four (4) corners.

Your professional partner

REFRIGERATED TROLLEYS

Ref: CRF20



- mm (BxDxH): 828 x 865 x 1876
- GN 2/1 rack capacity: 17
- GN 2/1 rack rails supplied: 5
- GN 2/1 plastic rod shelves supplied: 5
- Power (W): 550

- Key locked door.
- Made of stainless steel.
- GN 2/1 rod shelves supplied as standard five (5) units.
- Operating voltage and frequency: 230 V/1/50 Hz.

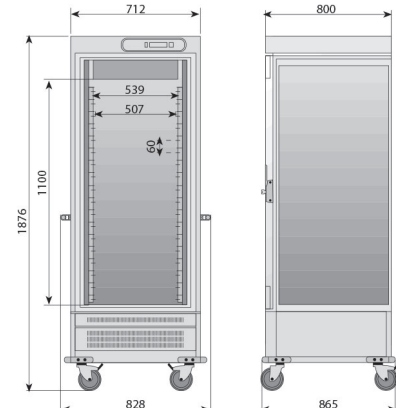

Ref: CRF40



- mm (BxDxH): 1518 x 865 x 1776
- GN 2/1 rack capacity: 40
- GN 2/1 rack rails supplied: 10
- GN 2/1 plastic rod shelves supplied: 10
- Power (W): 660

- Key locked door.
- Made of stainless steel.
- GN 2/1 rod shelves supplied as standard five (10) units.
- Operating voltage and frequency: 230 V/1/50 Hz.

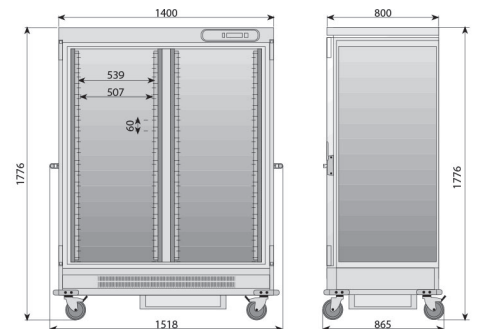



- Especially designed for the transportation of isothermal trays and GN containers.
- Doubled wall with an injected CFC-free, ecological polyurethane 40 Kg/m³ density isolation. With its highly-insulated walls, heat losses are reduced thus obtaining energy savings.
- Horizontal handle system for fast opening and closing of door.
- Automatic locking mechanism in hinges: when door is in a position of less than a 100° angle it gets fully closed, thus avoiding loss of temperature and achieving energy savings.
- Four (4) sound-proof castors of 160 mm diameter, two of them with brakes for an easy handling and safer use. Non-marking, special rubber bumpers to protect against direct impacts along the whole trolley base.
- Key locked door.
- Made of stainless steel.



Robust push handles located at both sides.



With its highly-insulated walls, heat losses are reduced thus obtaining energy savings.



Four (4) sound-proof castors of 160 mm diameter, two of them with brakes for an easy handling and safer use. Non-marking, special rubber bumpers to protect against direct impacts along the whole trolley base.

Your professional partner

INSULATED TROLLEYS FOR ISOTHERMAL TRAYS AND GN CONTAINERS

Ref: CNS10



- **mm (BxDxH):** 783 x 860 x 1207
- **Capacity:** 10
- **Type:** For Gastronorm containers
- Especially designed for the transportation of GN containers GN 1/1 (530 x 325 mm) and GN 2/1 (650 X 530 mm).
- 60 mm separation between rack rails.

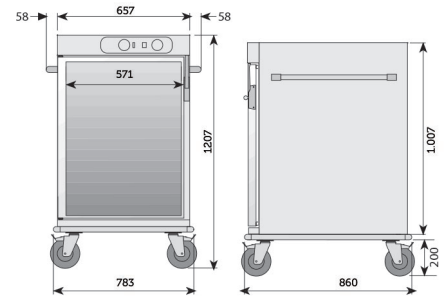

Ref: CNS20



- **mm (BxDxH):** 783 x 860 x 1640
- **Capacity:** 20
- **Type:** For Gastronorm containers
- Especially designed for the transportation of GN containers GN 1/1 (530 x 325 mm) and GN 2/1 (650 X 530 mm).
- 60 mm separation between rack rails.

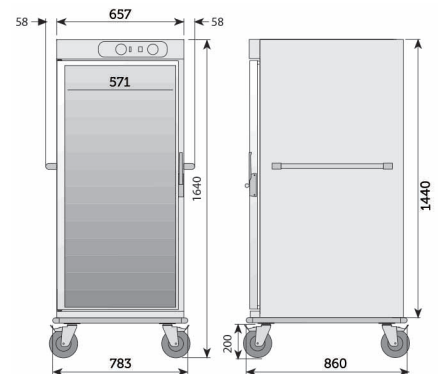

Ref: CNS20 ISO



- **mm (BxDxH):** 783 x 860 x 1640
- **Capacity:** 8
- **Type:** For isothermal trays
- Especially designed for the transportation of isothermal trays 530 x 375 x 110 mm.
- 60 mm separation between rack rails.

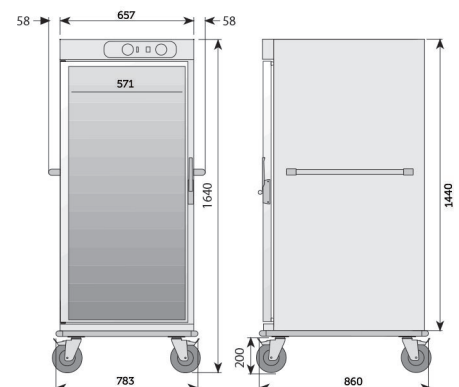



Diamond

catering equipment

Your professional partner