

04/2018

Mod: E7/BRI8

Production code: BBEBR77



Diamond
catering equipment

**TILTING PAN
OPERATING INSTRUCTIONS**

EN



**EBR77
EBRI77**

**EBR8
EBRV18**

**EBRV198
EBRVI/VC98T**

05/2016 - Ed 7 - Cod. n° 177380



ELEKTRYCZNY
ELECTRIC
ELEKTRISCH
ELECTRIQUE
ELÉCTRICO
ELÉTRICO
ELETTRICO
ЭЛЕКТРИЧЕСКИЕ ИЗДЕЛИЯ



0.

IDENTIFICAZIONE DOCUMENTO - DOCUMENT IDENTIFICATION
 IDENTIFICATION DU DOCUMENT - IDENTIFICACIÓN DEL DOCUMENTO
 DOKUMENT-KENNDATEN - IDENTIFICAÇÃO DO DOCUMENTO - IDENTYFIKACJA DOKUMENTU
 DOCUMENTIDENTIFICATIE - ИДЕНТИФИКАЦИЯ ДОКУМЕНТА - DOKUMENT IDENTIFIERING

CODICE DEL DOCUMENTO - DOCUMENT CODE - CODE DU DOCUMENT CÓDIGO DEL DOCUMENTO - DOKUMENTNUMMER - CÓDIGO DO DOCUMENTO KOD DOKUMENTU - DOCUMENTCODE - код документа - DOKUMENTKOD:	N° 177380
EDIZIONE - EDITION - EDITION - EDICIÓN - AUSGABE - EDIÇÃO - WYDANIE - EDITIE - UTGÅVA:	2016 Rev. 7 - 05/2016
TIPO DI DOCUMENTO - TYPE OF DOCUMENT - TYPE DE DOCUMENT - TIPO DE DOCUMENTO - DOKUMENT-TYP - TIPO DE DOCUMENTO - TYP DOKUMENTU - DOCUMENTTYPE - тип документа - TYP AV DOKUMENT:	M.U.
MODELLO - MODEL - MODÈLE - MODELO - MODELL - модель:	ELETTICO - ELECTRIC - ELECTRIQUE ELÉCTRICO - ELEKTRISCH - ELÉTRICO ELEKTRYCZNY - ЭЛЕКТРИКА - ELEKTRISK
ANNO DI COSTRUZIONE - YEAR OF CONSTRUCTION - ANNÉE DE FABRICATION - AÑO DE FABRICACIÓN - HERSTELLUNGSJAHR - ANO DE FABRICO - ROK PRODUKCJI - BOUWJAAR - ГОД ИЗГОТОВЛЕНИЯ - TILLVERKNINGSÅR:	2016
CONFORMITÀ - CONFORMITY - CONFORMITÉ - DECLARACIÓN DE CONFORMIDAD - KONFORMITÄT - CONFORMIDADE - ZGODNOŚĆ - CONFORMITEIT - НОРМАТИВНОЕ СООТВЕТСТВИЕ - ÖVERENSSTÄMMELSE:	CE

Targa di identificazione - Identification plate - Plaque d'identification - Placa de identificación - Typenschild - Placa de identificação - Tabliczka identyfikacyjna - Identificatielabel - Паспортная табличка - Identifieringsskylt.

- A - Indirizzo Costruttore - Manufacturer's Address - Adresse du Fabricant - Dirección del fabricante - Anschrift des Herstellers - Endereço do fabricante - Adres Producenta - Adres Fabrikant - Адрес изготовителя - Tillverkarens adress.
 B - Apparecchiatura Elettrica - Electrical Appliance - Appareil Electrique - Sistema eléctrico - Elektrogerät - Aparelhagem elétrica - Urządzenie Elektryczne - Elektrisch Apparaat - Электрооборудование - Elektrisk utrustning.
 C - Apparecchiatura Gas - Gas Appliance - Appareil à Gaz - Sistema de gas - Gasgerät - Aparelhagem a gás - Urządzenie Gazowe - Gasapparaat - Газовое оборудование - Gas utrustning.

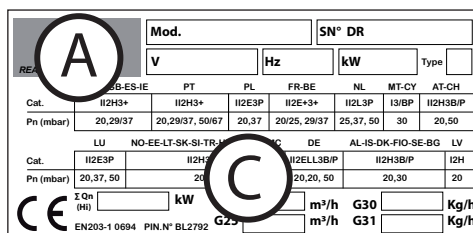
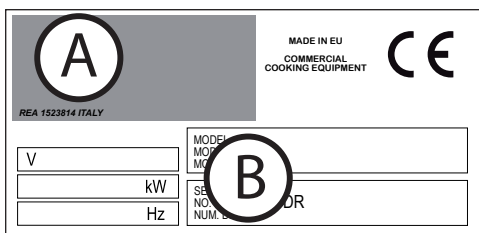

0.1

QUADRO NORMATIVO DI RIFERIMENTO - STANDARDS OF REFERENCE TABLEAU NORMATIF DE REFERENCE - MARCO REGLAMENTARIO DE REFERENCIA - REFERENZNORMEN - QUADRO NORMATIVO DE REFERÊNCIA - RAMY REGULACYJNE ODNIESIENIA - TABEL MET NORMREFERENTIES - СПРАВОЧНЫЕ НОРМАТИВНЫЕ СТАНДАРТЫ - REGELVERK

Direttiva Gas 2009/142/CE (ex-90/396/CEE) Gas Directive 2009/142 EC (ex-90/396/EEC) Directive Gaz 2009/142 CE (ex-90/396/CEE) Directiva sobre los aparatos de gas 2009/142/CE (ex-90/396/CEE) Gas-Richtlijn 2009/142/EG (ex-90/396/EWG) Diretiva Gás 2009/142/CE (ex-90/396/CEE) Dyrektywa o urządzeniach spalających paliwa gazowe 2009/142/WE (ex-90/396/EWG) Gasrichtlijn 2009/142/EG (ex-90/396/EEG) Директива ло газовому оборудованию 2009/142/EC (ранее-90/396/EEC) Gas direktiv 2009/142/EG (ex-90/396/CEE)	Direttiva Bassa Tensione 2006/95/CE Low Voltage Directive 2006/95/EC Directive Basse Tension 2006/95/CE Directiva de baja tensión 2006/95/CE Niederspannungsrichtlinie 2006/95/EG Diretiva baixa tensão 2006/95/CE Dyrektywa Niskonapięciowa 2006/95/WE Richtlijn lage Spanning 2006/95/EG Директива 2006/95/ЕС ло низковольтному оборудованию Lavspänningsdirektivet 2006/95/CE Lågspänningsdirektivet 2006/95/EC	Direttiva EMC 2004/108/CE EMC Directive 2004/108/EC Directive EMC 2004/108/CE Directiva EMC 2004/108/CE EMV-Richtlinie 2004/108/EG Diretiva EMC 2004/108/CE Dyrektywa EMC 2004/108/WE EMC Richtlijn 2004/108/EG Директива 2004/108/EC ло электромагнитной совместимости EMC direktivet 2004/108/EC	Smaltimento Apparecchiature elettriche ed elettroniche Waste electrical and electronic equipment Démantèlement des Appareils électriques et électroniques Desguace de equipos eléctricos y electrónicos Entsorgung elektrischer und elektronischer Altgeräte Eliminação das aparelhagens elétricas e eletrônicas Utylizacja odpadów elektrycznych i elektronicznych Afgedankte Elektrische en Elektronische Apparaten Утилизация электрического и электронного оборудования Avyttring av elektriska och elektroniska produkter
GAS-GÁS-GAZ GAZOWY-ГАЗ ELETTRICO ELECTRIC ELECTRIQUE ELÉCTRICO ELEKTRISCH ELÉTRICO ELEKTRYCZNY ЭЛЕКТРИЧЕСКАЯ ELEKTRISK	EN 62233:2008; EN 60335-2-39:2003 + A1:2008 + A11:2012 EN 60335-1:2012	EN 55014-1:2006 + A1:2009 + A2:2011 EN55014-2:1997 + A1:2001 + A2:2008 EN61000-3-2:2006 + A1:2009 + A2:2009 EN61000-3-3:2008	DIRETTIVA 2011/65/EU (ROHS II) DIRETTIVA 2012/19/EU (WEEE)

TABLE OF CONTENTS

- 0. DOCUMENT IDENTIFICATION**
- 0.1 STANDARDS OF REFERENCE**
- 1. INFORMATION FOR USERS**
 - Foreword - Purpose of document - How to read the document
 - Keeping the document - Addressees - Operator training program
 - Pre-arrangements depending on customer - Contents of supply - Intended use
 - Allowed operational and environmental conditions
 - Test inspection and warranty
- 2. GENERAL SAFETY INFORMATION**
 - Foreword - Obligations - Prohibitions - Advice - Recommendations
 - Indications concerning residual risks
 - What to do if you smell gas in the room
- 3. INSTRUCTIONS FOR USE - 700**
 - Location of main control components
 - Knobs, keys and indicator light modes and functions
- 3. INSTRUCTIONS FOR USE - 900-980**
 - Location of main control components
 - Knobs, keys and indicator light modes and functions
- 3. INSTRUCTIONS FOR USE**
 - Description of stop modes
 - Stoppage due to faulty operations/Emergency stop
 - Stoppage during a work phase
 - Commissioning
 - Cleaning at commissioning
 - Daily activation/Daily and prolonged deactivation
- 3. INSTRUCTIONS FOR USE - 700**
 - Starting production/Loading cooking compartment/Switch On/Switch Off
- 3. INSTRUCTIONS FOR USE - 900-980**
 - Starting production/Loading cooking compartment/Switch On/Switch Off
- 3. INSTRUCTIONS FOR USE**
 - Unloading the product/Deactivation
- 4. ROUTINE MAINTENANCE**
 - Obligations - Prohibitions - Advice - Recommendations
 - Daily cleaning/Cleaning for prolonged deactivation
 - Summarised table: qualification - operation - frequency
 - Troubleshooting
- 5. WASTE DISPOSAL**
 - Deactivation and scrapping of appliance
 - Waste disposal

1. INFORMATION FOR USERS

Foreword

This document has been drawn up in the mother language of the manufacturer (Italian). The information it contains is for the sole use of the operator authorised to use the appliance in question.

Operators must be trained concerning all aspects regarding functioning and safety. Special safety prescriptions (Obligations-Prohibitions-Dangers) are carried in a specific chapter concerning these issues. This document cannot be handed over to third parties to take vision of it without written consent by the manufacturer. The text cannot be used in other publications without the written consent of the manufacturer. The use of: Figures/Images/ Drawings/Layouts inside the document, is purely indicative and can undergo variations. The manufacturer reserves the right to modify it, without being obliged to communicate his acts.

Purpose of the document

Every type of interaction between the operator and the appliance during its entire life cycle has been carefully assessed both during designing and while drawing up this document. We therefore hope that this documentation can help to maintain the characteristic efficiency of the appliance. By strictly keeping to the indications it contains, the risk of injuries while working and/or of economical damage is limited to a minimum.

How to read the document

The document is divided into chapters which gather by topics all the information required to use the appliance in a risk-free way. Each chapter is divided into paragraphs; each paragraph can have titled clarifications with subtitles and descriptions.

Keeping the document

This document is an integral part of the initial supply. It must therefore be kept and used appropriately during the entire operational life of the appliance.

Addressees

This document is structured for the exclusive use of the "Generic" operator (Operator with limited responsibilities and tasks). Person authorised and employed to operate the appliance with guards active and capable of performing routine maintenance (cleaning the appliance).

Operator training program

Upon specific demand by the user, a training course can be held for operators in charge of using the appliance, following the modalities provided in the order confirmation.

Depending on the demand, preparation courses can be held at the site of manufacturer or of the user, for:

- Homogeneous operator in charge of electric/electronic maintenance (Specialised technician);
- Homogeneous operator in charge of mechanical maintenance (Specialised technician);
- Generic operator for simple operations (Operator - Final user).

Pre-arrangements depending on customer

Unless different contractual agreements were made, the following normally depend on the customer:

- setting up the rooms (including masonry work, foundations or channelling that could be requested);
- smooth, slip-proof, perfectly level floor;
- pre-arrangement of installation place and installation of equipment respecting the dimensions indicated in the layout (foundation plan);
- pre-arrangement of auxiliary services adequate for requirements of the system (electrical mains, waterworks, gas network, drainage system);
- pre-arrangement of electrical system in compliance with regulatory provisions in force in the place of installation;
- sufficient lighting, in compliance with standards in force in the place of installation;
- safety devices upstream and downstream the energy supply line (residual current devices, equipotential earthing systems, safety valves, etc.) foreseen by legislation in force in the country of installation;
- earthing system in compliance with standards in force;
- pre-arrangement of a water softening system, if needed (see technical details).

Contents of the supply

- Appliance
 - Lid/s
 - Metallic rack/s
 - Rack support grid
 - Pipes and/or wires for connections to energy sources (only when indicated in work order).
- The supply may vary depending on the order.

1. INFORMATION FOR USERS

Intended use

Original instructions. This device is intended for professional use. The use of the appliance treated in this document must be considered "Proper Use" if used for cooking or regeneration of goods intended for alimentary use; any other use is to be considered "Improper use" and therefore dangerous. The appliance must be used according to the foreseen conditions stated in the contract within the prescribed capacity limits carried in the respective paragraphs. It is strictly forbidden to use the tilting pan as a fryer.

Allowed operating conditions

The appliance has been designed to operate only inside of rooms within the prescribed technical and capacity limits. The following indications must be observed in order to attain ideal operation and safe work conditions. The appliance must be installed in a suitable place, namely, one which allows normal running, routine and extraordinary maintenance operations. The operating area for maintenance must be set up in such a way that the safety of the operator is not endangered.

The room must also be provided with the features required for installation, such as:

- maximum relative humidity: 80%;
- minimum cooling water temperature > + 10 °C ;
- the floor must be anti-slip, and devices positioned perfectly level;
- the room must be equipped with a ventilation system and lighting as prescribed by standards in force in the country of the user;
- the room must be set up for draining greywater, and must have switches and gate valves which cut all types of supply upstream the appliance when needed;
- The walls/surfaces immediately close/contact to the appliance must be fireproof and/or isolated from possible source of heat

Test inspection and warranty

Testing: the equipment has been tested by the manufacturer during the assembly stages at the site of the production plant. All certificates relating to the testing carried out we will be delivered to the customer.

Warranty: The guarantee is of 12 months from invoice date and it covers the faulty parts only. Carriage and installation charges are for the buyer's account. Electric components, accessories as well as other removable parts are not covered by the guarantee.

Labor costs relating to the intervention of authorized by the manufacturer at the customer's premises, for removal of defects under warranty are charged to the dealer, except in cases where the nature of the defect is such that it can be easily removed on site by the customer.

Excluded are all tools and supplies, possibly supplied by the manufacturer together with the machines.

Damage occurred in transit or due to incorrect installation or maintenance can't be considered. Guarantee is not transferable and replacement of parts and appliance is at the final discretion of our company. The manufacturer is responsible for the device in its original setting.

The manufacturer declines all responsibility for improper use, for damages caused as a result of operations not covered in this manual or not authorized in advance by the manufacturer.

The warranty terminates in case of:

• Damage caused by transportation and/or handling. Should this occur, the customer must inform the dealer and carrier via fax or RR and must write what has happened on the copies of the transportation documents. The specialised technician installing the appliance will assess whether it can be installed depending on the damage.

The warranty also terminates in the presence of:





- Damage caused by incorrect installation;
- Damage caused by parts worn due to improper use;
- Damage caused by use of unadvised or non-original spare parts;
- Damage caused by incorrect maintenance and/or lack of maintenance;
- Damage caused by failure to comply with the procedures described in this document.

Authorisation















Authorisation refers to the permission to operate an activity intrinsic to the appliance.

Authorisation is given to anyone who is responsible for the appliance (manufacturer, purchaser, signer, dealer and/or location owner).

Foreword





	The operating instructions have been drawn up for the "Generic" operator (Operator with limited responsibilities and tasks). Person authorised and employed to operate the appliance with guards active and capable of performing routine maintenance (cleaning the appliance).
	The operators who use the appliance must be trained in all aspects concerning its functioning and safety features. They must therefore interact using appropriate methods and instruments, complying with required safety standards.
	This document does not include information regarding transportation, installation and extraordinary maintenance which must be performed by technicians qualified for the relevant operation.
	The "Generic" operator to whom this document is intended must operate on the appliance after the technician has completed installation (transportation, fixing electrical, water, gas and drain connections).
	This document does not include information regarding every modification or variation on the appliance. The manufacturer reserves the right to modify it, without being obliged to communicate his acts.

Obligations - Prohibitions - Advice - Recommendations

	Upon reception, open the packaging and make sure that the appliance and accessories have been damaged during transportation. If damage is found, report it promptly to the carrier and do not install the appliance. Contact qualified and authorised personnel to report the problem detected. The manufacturer is not liable for damage caused during transportation.
	Unauthorised persons (including children, disabled individuals and people with limited physical, sensory and mental abilities) are prohibited from performing any procedures. Generic operators are prohibited from performing any procedures reserved for qualified and authorised technicians.
	Read the instructions before acting.
	Disconnect all supplies (electrical - gas - water) upstream the appliance whenever you need to work in safe conditions.
	Wear protective equipment suitable for the operations to be performed. As far as personal protective equipment is concerned, the European Community has issued Directives which the operators must comply with. Noise ≤ 70 dB
	Do not leave flammable objects or material near the appliance. Do not obstruct the heat extraction and/or dissipation openings.
	Refer to standards in force for disposal of special waste.
	When loading the product into the appliance and unloading it, there is a residual risk of being burnt; this risk can occur coming into unintentional contact with: surfaces, trays, processed material.
	Use the cooking vessels in such a way that while the product is cooking, they are in the operator's sight. Liquid containers can spill during cooking, thus creating dangerous situations.
	Failure to keep the appliance in hygienic conditions could cause it to deteriorate quickly, influencing operation and creating dangerous situations.
	It is strictly forbidden to tamper with or remove the plates and pictograms applied to the equipment.
	Store this document carefully, so that it is available for whoever uses the appliance, consulting it when needed.
	The controls on the appliance can only be switched by hand. Damage caused by sharp objects or the likes terminate all and any warranty rights.
	In order to minimise the risk of shocks or fire, do not connect or disconnect the unit with wet hands.
	Whenever you access the cooking area, always remember that the danger of being burnt persists. It is therefore mandatory to take appropriate measures for personal protection.

Indications concerning residual risks

Though the rules for "good manufacturing practice" and the provisions of law which regulate manufacturing and marketing of the product have been implemented, "residual risks" still remain which, due to the very nature of the appliance, were not possible to eliminate. These risks include:

	Residual risk of electrocution: This risks remains when intervening on live electrical and/or electronic devices.
	Residual risk of burning: This risks remains when unintentionally coming into contact with materials at high temperatures.
	Residual risk of burning due to leaking material This risks remains when unintentionally coming into contact with containers too full of liquids and/or solids which when heated change morphology (passing from a solid state to a liquid state) and can cause burning if used improperly. During work, the containers which are used must be positioned at easily visible levels.
	Residual risk of explosions This risk remains when: <ul style="list-style-type: none"> • there is smell of gas in the room; • appliance used in an atmosphere containing substances which risk exploding; • using food in closed containers (such as jars and cans), if they are not suitable for the purpose; • using with flammable liquids (such as alcohol).
	Residual risk of fire This risk remains when: <ul style="list-style-type: none"> • the pasta cooker is used as a fryer. • using with flammable liquids (such as alcohol).

Location of main components

1. Switch-on knob (see Knobs, keys and indicator light modes and functions).
2. Thermostat knob (see Knobs, keys and indicator light modes and functions).
3. Gate valve filling water into cooking compartment.
4. Flywheel for moving cooking compartment
5. Cooking compartment
6. Cover opening/closing handle
7. Pipe for introducing water in cooking compartment

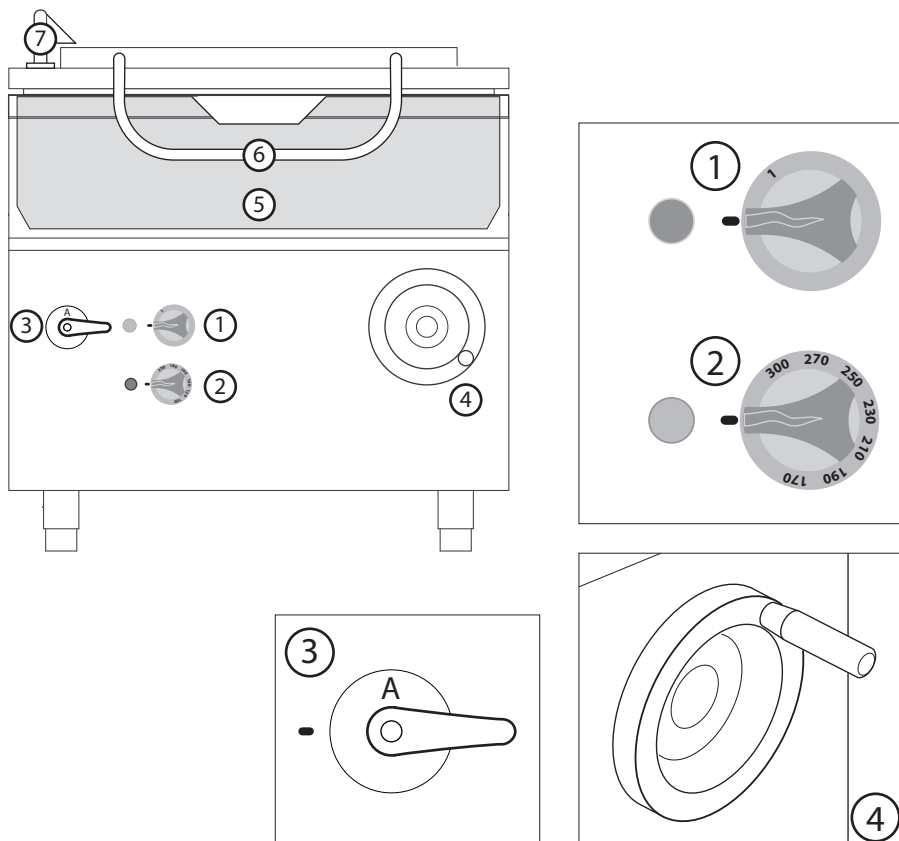

Knobs, keys and indicator light modes and functions

	<p>Thermostat knob (ELECTRIC). It performs two different functions:</p> <ol style="list-style-type: none"> 1. Adjusting cooking temperature. 2. Heating phase Start/Stop.
	<p>Switch-on knob (ELECTRIC). Performs one function:</p> <ol style="list-style-type: none"> 1. Switches electricity inside circuit on and off.
	<p>Yellow indicator light (GAS/ELECTRIC): When present, the indicator is subordinated to use of the thermostat knob. Lighting of the indicator signals the heating phase.</p>
	<p>Green indicator light (GAS/ELECTRIC): The indicator is subordinated to use of the switch-on knob. Lighting of the indicator signals the operating phase.</p>

Location of main components

1. Electric switch-on knob (see Knobs, keys and indicator light modes and functions)
2. Thermostat knob
3. Filling water gate valve inside cooking compartment
4. Flywheel for moving cooking compartment
5. Cooking compartment
6. Cover opening/closing handle
7. Pipe for introducing water in cooking compartment

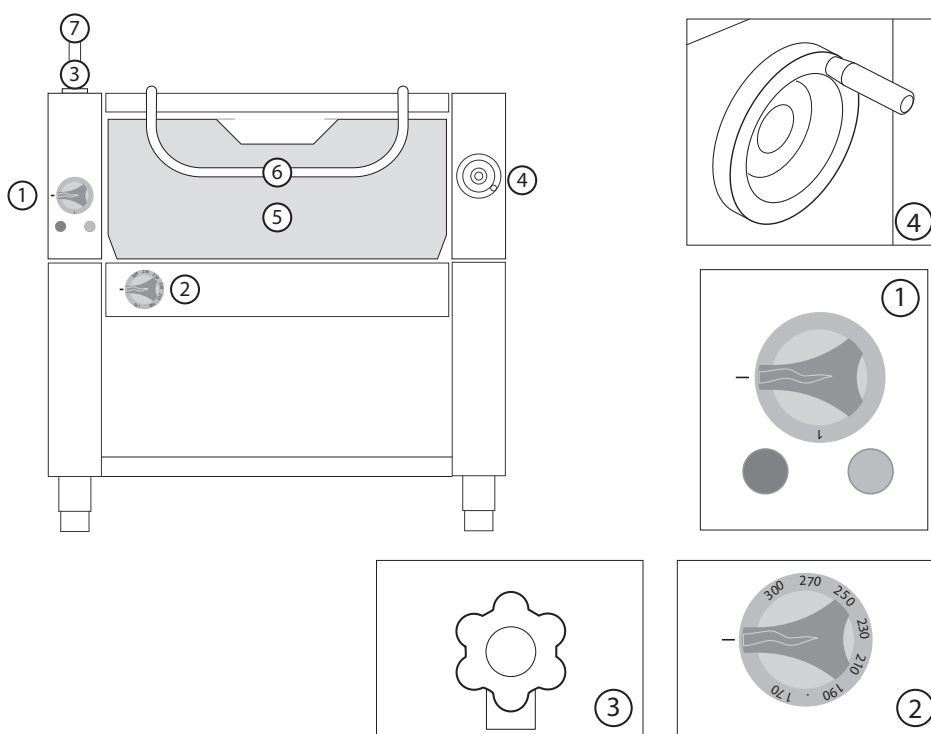



Knobs, keys and indicator light modes and functions

	<p>Switch-on knob (ELECTRIC). Performs one function:</p> <ol style="list-style-type: none"> 1. Switches electricity inside circuit on and off.
	<p>Thermostat knob (ELECTRIC). It performs two different functions:</p> <ol style="list-style-type: none"> 1. Adjusting cooking temperature. 2. Heating phase Start/Stop.
	<p>Water filling gate valve (GAS/ELECTRIC). Functions:</p> <ol style="list-style-type: none"> 1. Open water flow inside cooking compartment. 2. Close water flow inside cooking compartment.
	<p>Yellow indicator light (GAS/ELECTRIC): When present, the indicator is subordinated to use of the thermostat knob. Lighting of the indicator signals the heating phase.</p>
	<p>Green indicator light (GAS/ELECTRIC): The indicator is subordinated to use of the switch-on knob. Lighting of the indicator signals the operating phase.</p>

3. INSTRUCTIONS FOR USE

Description of stop modes

	In stoppage conditions caused by faults and emergencies, in the event of imminent danger, it is mandatory to close all the locking devices on the supply lines upstream the appliance (Electrical-Water-Gas).
	The drawing illustrates the various positions the knobs take on during an emergency stop (A1-B1-C1-D1-E1) and stoppage during a working phase (A2-B2-C2-D2-E2).

Stoppage due to faulty operations

Safety thermostat

Standard supply with following models:

- Fryer (present on all models)
- Tilting Pan (present on all models)
- Pot (present on all models)
- Pasta cooker (only with Electric model)
- Stove (present on all models with electric oven)
- Frytop present on all electric models (only for 900-980)
- Lava stone (not present)
- Bain-marie (not present)
- All hotplate (only for 900-980: present on all models with gas oven)

Stop: In situations or circumstances which can be dangerous, a safety thermostat is triggered, automatically stopping heat generation. The production cycle is interrupted until the cause of the fault is resolved.

Restarting: After the problem that triggered the safety thermostat is resolved, the authorised technician can restart the appliance by means of the specific controls.

Emergency stop

In situations or circumstances which can be dangerous, turn the knob to “Zero” depending on the model (A-B-C-D-E-1). See knobs, keys and indicator light modes and functions.

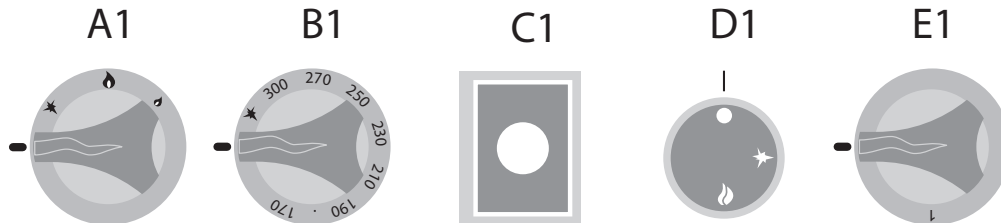

Stoppage during a work phase

In situations or circumstances which require temporary stop of heat generation, act as follows:





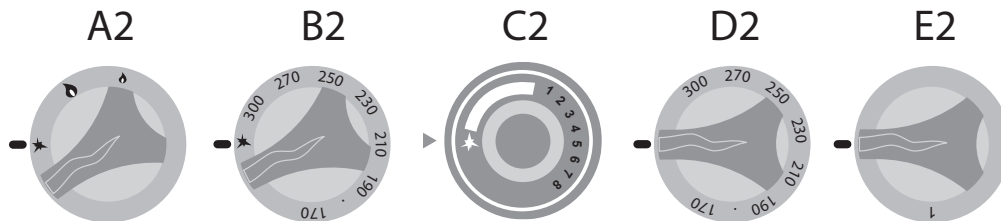

- Gas Appliance: Turn the knobs to the piezoelectric position (A-B-C-2), the pilot light remains lit as the gas flow in the burner is not interrupted.
- Electric Appliance: Turn the knobs “D2-E2” to “Zero” to stop heat generation.

(See knobs, keys and indicator light modes and functions).



3. INSTRUCTIONS FOR USE

Commissioning

	When commissioning the appliance and when starting it after a prolonged stop, it must be thoroughly cleaned to eliminate all residue of extraneous material (See Routine Maintenance).
    	Cleaning at commissioning Do not use pressurised or direct water jets to clean the appliance. Remove the outer protective film by hand and thoroughly clean all the outside parts of the appliance. At the end of the operations described for cleaning the outside parts, proceeded as instructed in "Daily Cleaning" (See Routine Maintenance).

Daily activation

Procedure:

1. Check the cleanliness and hygiene of the appliance.
2. Make sure that the room exhaust system works properly.
3. When necessary, plug the appliance into the appropriate socket.
4. Open the network locks upstream the appliance (Gas - Water - Electric).
5. Make sure that the water drain (if present) is not clogged.
6. Proceed with the operations described in "Starting production".





Daily and prolonged deactivation

Procedure:

1. Close the network locks upstream the appliance (Gas - Water - Electric).
2. Make sure that the drain cocks (if present) are "Closed".
3. Check the cleanliness and hygiene of the appliance (See Routine Maintenance).

	In the event of prolonged inactivity, protect the parts more exposed to oxidation as described in the specific chapter (See Routine Maintenance).
---	---

Starting production





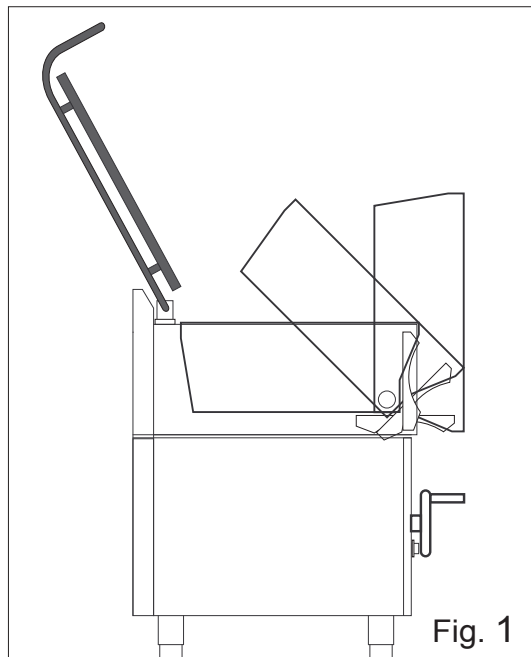

	It is strictly forbidden to use the tilting pan as a fryer.
	Before proceeding with these operations, see "Daily activation".
	When loading the product into the appliance and unloading it, there is a residual risk of being burnt; this risk can occur coming into unintentional contact with: hob - cooking compartment - recipients or material processed.
	Take appropriate measures for personal protection. Wear protective equipment suitable for the operations to be performed.

Loading cooking compartment

Make sure the cooking compartment is in the horizontal position (Fig.2-3).

Lift the lid of the tilting pan (Fig. 2)



	The cooking compartment must be moved with the lid up (Open) Fig.1.
	When filling the cooking compartment, respect the maximum level indicated by the notch on the inside (Fig. 4 A).
	Water may be introduced into the cooking compartment by acting on the water filling gate valve: <ul style="list-style-type: none"> • open, adjust the amount of water you wish and close again.
	In order to fill the cooking compartment with water, you must: <ul style="list-style-type: none"> - lift the lid of the cooking compartment if necessary, - turn the water outlet pipe towards the cooking compartment, - open the water filling gate valve (Fig. 5 A), - fill the tank as required, - close the gate valve (Fig. 6 A), - position the water outlet pipe so it does not get in the way of the lid when it closes. Lower the lid of the cooking compartment if necessary.
	Do not use large pieces of kitchen salt as it deposits at the bottom and does not completely dissolve.
	The tilting pan must be switched on after having filled the cooking compartment with the material to be processed. Do not switch it on when the cooking compartment is empty.

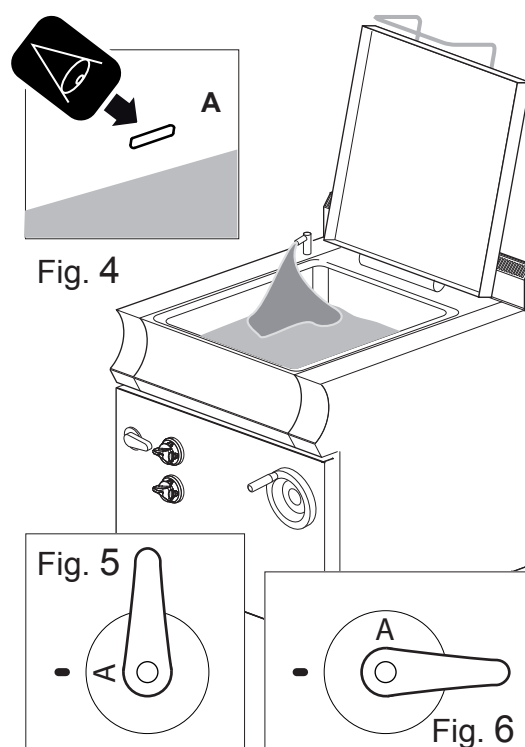
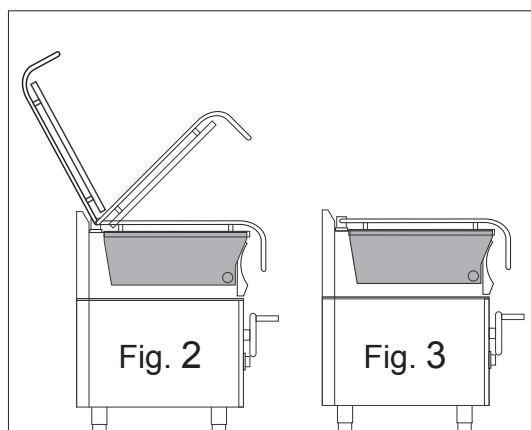

Load the product to be cooked inside the cooking compartment.

When it has been loaded, lower the lid (Fig. 3) and switch the appliance on.

Switching On/Off



The appliance must be switched on after having filled the cooking compartment with the material to be processed. Do not switch it on when the cooking compartment is empty.

When the operations described on the previous page have been performed successfully, do as follows to begin cooking:

1. Turn the switch-on knob to "1". When the green light is on it means the operation is in progress (Fig. 7).
2. Turn the thermostat knob to adjust the cooking temperature. When the yellow light is on it means heating is in progress (Fig. 8).
3. Turn the thermostat knob to "Zero" (Fig. 8A) to stop heat generation.
4. Turn the knob to "Zero" (Fig. 7A) to switch the appliance off at the end of the work cycle.



During operation, check the level of the water inside the cooking compartment and bring it to the correct level as needed by acting on the water filling gate valve. Be careful of the residual risk of being burnt while topping up the water. Use adequate prevention and protection equipment.

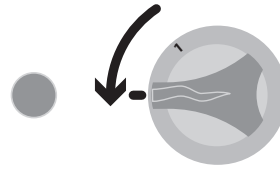

Fig. 7

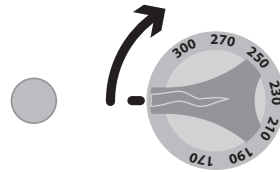

Fig. 8

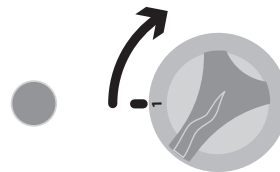

Fig. 7A

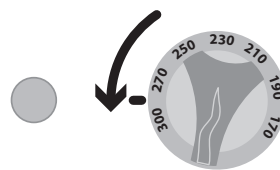





Fig. 8A

Starting production

	It is strictly forbidden to use the tilting pan as a fryer.
	Before proceeding with these operations, see "Daily activation".
	When loading the product into the appliance and unloading it, there is a residual risk of being burnt; this risk can occur coming into unintentional contact with: hob - cooking compartment - recipients or material processed.
	Take appropriate measures for personal protection. Wear protective equipment suitable for the operations to be performed.

Loading cooking compartment

Make sure the cooking compartment is in the horizontal position (Fig.2-3).

Lift the lid of the tilting pan (Fig. 2)

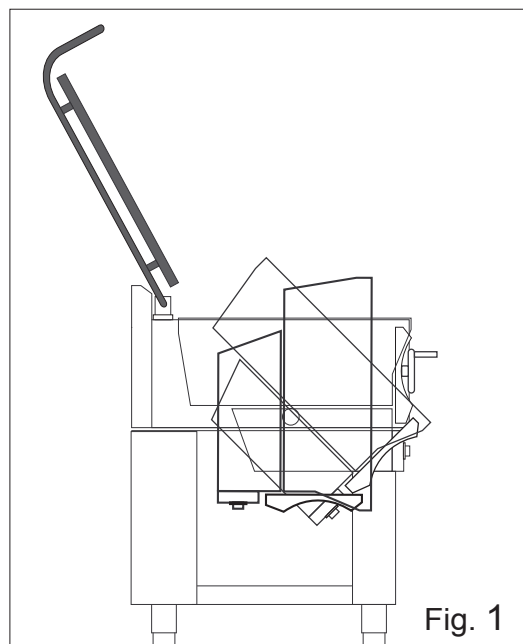







Fig. 1

	The cooking compartment must be moved with the lid up (Open) Fig.1.
	When filling the cooking compartment, respect the maximum level indicated by the notch on the inside (Fig. 4 A).
	Water may be introduced into the cooking compartment by acting on the water filling gate valve: <ul style="list-style-type: none"> • open, adjust the amount of water you wish and close again.
	In order to fill the cooking compartment with water, you must: <ul style="list-style-type: none"> - lift the lid of the cooking compartment if necessary, - turn the water outlet pipe towards the cooking compartment, - open the water filling gate valve (Fig. 5 A), - fill the tank as required, - close the gate valve (Fig. 6 A), - position the water outlet pipe so it does not get in the way of the lid when it closes. Lower the lid of the cooking compartment if necessary.
	Do not use large pieces of kitchen salt as it deposits at the bottom and does not completely dissolve.
	The tilting pan must be switched on after having filled the cooking compartment with the material to be processed. Do not switch it on when the cooking compartment is empty.

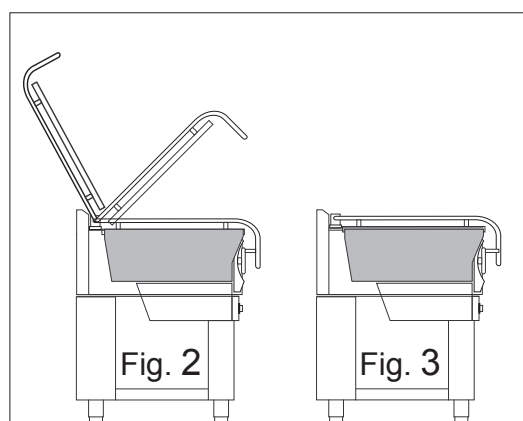

Fig. 2

Fig. 3

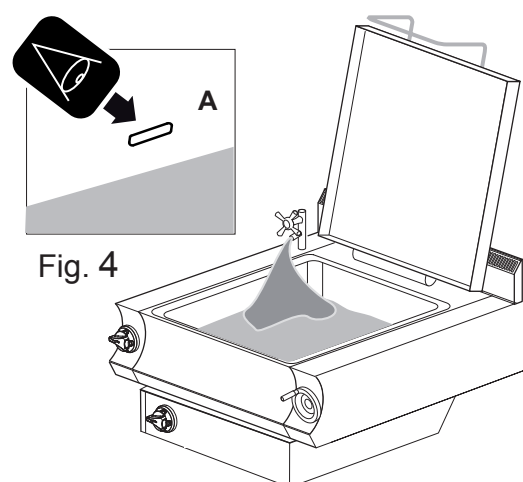

Fig. 4

Load the product to be cooked inside the cooking compartment.

When it has been loaded, lower the lid (Fig. 3) and switch the appliance on.

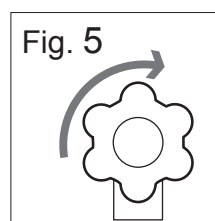

Fig. 5

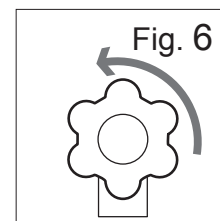

Fig. 6

Switching On/Off

When the operations described on the previous page have been performed successfully, do as follows to begin cooking: Turn the knob (Fig. 7 A) to "1". When the green light is on (Fig. 7 C) it confirms the operating phase.

Turn the thermostat knob to the desired position (Fig. 8 E) to set the cooking temperature.

When the yellow indicator light is on it means that the heat-up phase is in progress (Figure 7 D).

Turn to "0" (Fig. 8 F) to stop the operation of the thermostat knob.

Turn the knob to "0" (Fig. 7 B) to completely stop the appliance.

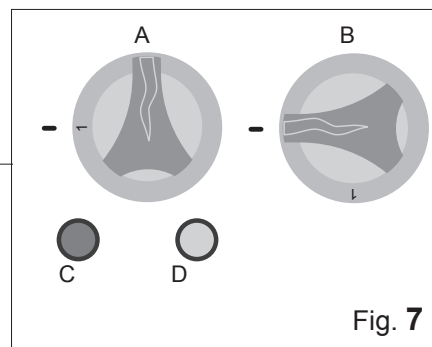

Fig. 7

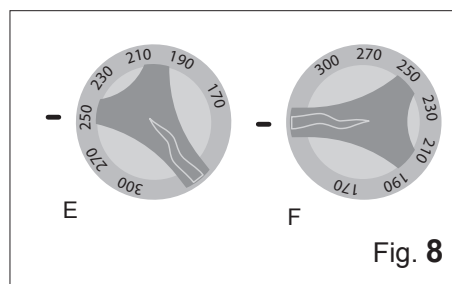
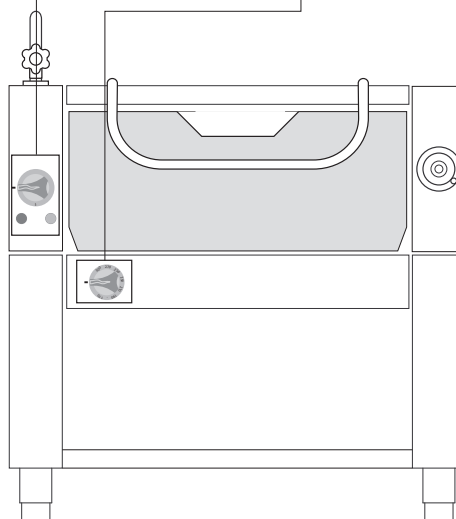





Fig. 8



3. INSTRUCTIONS FOR USE

Unloading the product

	Move the cooking compartment only after having positioned an appropriate recipient below the product outlet.
	When unloading the product, fill the collection recipient halfway for safe handling.
	Take appropriate measures for personal protection. Wear protective equipment suitable for the operations to be performed.

When cooking is over, position and block a recipient (with appropriate material and capacity) underneath the cooking compartment (Fig. 9 A/B).

Unloading product from cooking compartment:



- Lift the lid of the cooking compartment all the way (Fig.10);
- the container suitable to receive the product (Fig. 9A/B) must not obstruct flywheel rotation (Fig.11);
- Begin turning the flywheel stepping to the side of the appliance (Fig.11). As the cooking compartment moves it will allow the product to slide towards the container;
- Act on the flywheel to increase or decrease inclination of the cooking compartment and therefore unloading speed;
- Keep an eye on the filling of the recipient.

	The material inside the collection container must not overflow.
---	---

- When the cooking compartment has been emptied, put the cooked product in a place prepared beforehand.
- If necessary, repeat the aforementioned operations until the cooking compartment is empty.
- After the product has been unloaded, load it once again (see "Loading Cooking Compartment") or else perform the operations described in "Deactivation".

Deactivation

At the end of the work cycle, turn the knobs on the appliance to "Zero".

	If present, the indicator lights must be off at the end of the work cycle.
	The appliance must be cleaned regularly and every incrustation or food deposit removed. See chapter: "Cleaning instructions"





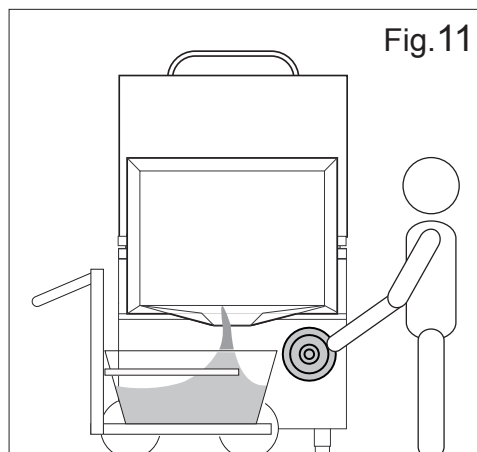
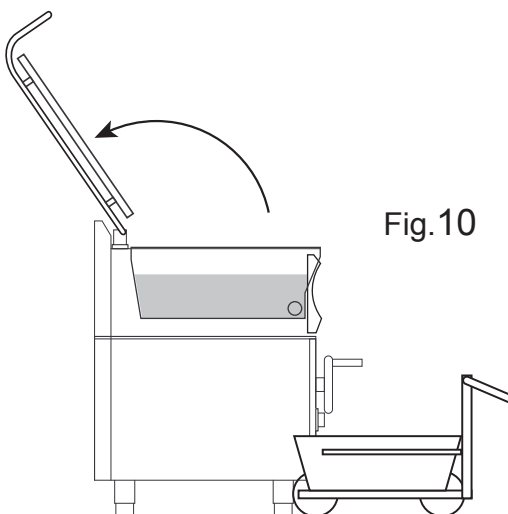
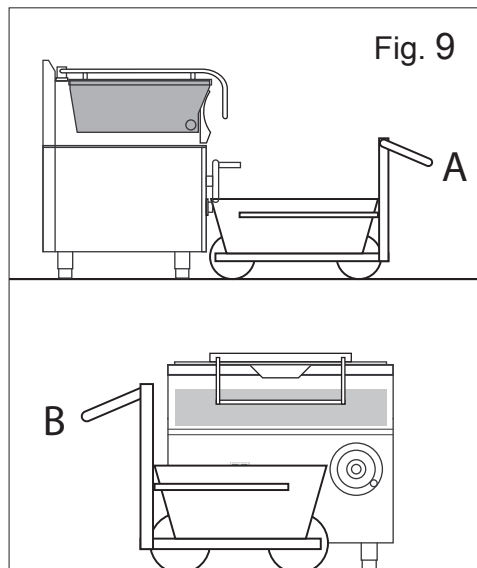















Check the cleanliness and hygiene of the appliance. See "Cleaning instructions".

Close the network locks upstream the appliance (Gas - Water - Electric).





4. ROUTINE MAINTENANCE

Obligations - Prohibitions - Advice - Recommendations



	If the appliance is connected to a flue, the exhaust pipe must be cleaned according to that foreseen by specific regulatory provisions of the country (contact your installer for information).
	To make sure that the appliance is in perfect technical conditions; have it serviced at least once a year by an authorised technician of the assistance service.
	Unauthorised persons (including children, disabled individuals and people with limited physical, sensory and mental abilities) are prohibited from performing any procedures. Performing any procedures without first having read all the documentation is strictly prohibited.
 	Whenever you access the cooking area, always remember that the danger of being burnt persists. It is therefore mandatory to take appropriate measures for personal protection.
 	Disconnect electrical power upstream the appliance whenever you need to work in safe conditions to perform cleaning or maintenance
	Wear protective equipment suitable for the operations to be performed. As far as personal protective equipment is concerned, the European Community has issued Directives which the operators must comply with.
	The appliance is used to prepare food products. Keep the appliance and the surrounding area constantly clean. Failure to keep the appliance in ideal hygienic conditions could cause it to deteriorate quickly and create dangerous situations.
	Filth deposit built up near heat sources can burn during normal use of the appliance and create dangerous situations. The appliance must be cleaned regularly and every incrustation or food deposit removed.
	The chemical effect of salt and/or vinegar or other acid substances can in the long run cause the inside of the cooking compartment to corrode during cooking. At the end of the cooking cycle of such substances, the appliance must be washed thoroughly with detergent, abundantly rinsed and carefully dried.
	Be careful not to damage stainless steel surfaces. Do not use corrosive products, abrasive material or sharp tools.
	The liquid detergent for cleaning the cooking compartment must have certain chemical features: pH greater than 12, without chlorides/ammonia, viscosity and density similar to water. Use non-aggressive products for cleaning the inside and outside of the appliance (use detergents on the market for cleaning steel, glass and enamel).
	Carefully read the indications carried on the labels of the products used. Wear protective equipment suitable for the operations to be performed (see the protective equipment carried on the package label).
	Do not use pressurised or direct water jets to clean the appliance. Rinse the surfaces with tap water and dry them with an absorbent cloth or other non-abrasive material.
	In the event of prolonged inactivity, besides disconnecting the supply lines, you must thoroughly clean all the inside and outside parts of the appliance.
	Before performing any of the cleaning operations described hereafter, the operator must have had a look at the whole document.
   	Refer to standards in force for waste disposal.







4. ROUTINE MAINTENANCE



	<p>Before proceeding with the operations below, see: Obligations - Prohibitions - Advice - Recommendations, described on the previous page.</p>
	<p>Daily cleaning Remove everything from the cooking compartment.</p> <p>Use a standard sprayer to apply the liquid detergent on the whole surface (cooking compartment, lid and all exposed surfaces) and using a non-abrasive sponge, clean the entire appliance thoroughly by hand.</p> <p>When finished, rinse abundantly with tap water (do not use pressurised and/or direct water jets). Have water flow out of the cooking compartment using the movement system. Move the cooking compartment only after having positioned an appropriate recipient below the drainage gate valve to carry out drainage.</p> <p>Fill the recipient halfway to handle it safely. Empty the container in compliance with waste disposal procedures in force in the country where the appliance is used and reposition the emptied recipient in its housing.</p> <p>Repeat the aforementioned operations until the cooking compartment is empty.</p> <p>When these operations have been performed successfully, dry the cooking compartment carefully using a non-abrasive cloth.</p> <p>In order to eliminate all humidity, once routine cleaning has been finished, turn the appliance on and run it at minimum for approximately 2/3' and then turn it back off (see procedure part 3 Instructions for use: Switching On/Off).</p> <p>If necessary, repeat the operations described above for a new cleaning cycle.</p>
	<p>Cleaning for prolonged deactivation</p> <p>When the appliance remains idle for a long time, perform all the described daily cleaning procedures. When the operations are over, protect the parts more exposed to oxidation doing as follows. Therefore:</p> <ul style="list-style-type: none"> • Use lukewarm water with a bit of soap to clean the parts; • Rinse the parts thoroughly, without using pressurised and/or direct water jets; • Dry the surfaces carefully using non-abrasive material; • Pass over all the stainless steel surfaces using a non-abrasive cloth slightly moistened with Vaseline to create a protective coating. <p>For appliances with doors and rubber gaskets, leave the door slightly ajar to let it air out and spread protective talcum powder on the rubber gasket surfaces.</p> <p>Air out the appliances and rooms regularly.</p>

4. ROUTINE MAINTENANCE

Summarised table: qualification - operation - frequency

	Generic operator Person authorised and employed to operate the appliance with guards active, capable of performing routine tasks.
	Homogeneous operator Expert operator authorised for handling, transporting, installing, servicing, repairing and scrapping the equipment.

	OPERATION	FREQUENCY
	Cleaning at commissioning	Upon arrival after installation
	Cleaning appliance	Daily
	Cleaning parts in contact with foodstuff	Daily
	Cleaning flue	Yearly
	Checking thermostat	Yearly
	Checking micro switch	Yearly
	Checking safety valve	Every 6 months

	Should a problem occur, the generic operator performs the first search and, if qualified, eliminates the cause of the problem and restores the appliance correctly
	If the problem cannot be resolved, turn the appliance off, disconnect it from the electrical mains and shut all the supply valves. Then contact authorized customer service
	The maintenance technician intervenes when the generic operator was not able to pinpoint the cause of the problem, or whenever restoration of correct operation of the appliance entails executing operations for which the generic operator is not qualified

4. ROUTINE MAINTENANCE

Troubleshooting



Whenever the appliance does not work properly, try to solve the less serious problems using this table.

FAULT	POSSIBLE CAUSE	INTERVENTION
The appliance does not turn on.	<ul style="list-style-type: none"> The master switch is not connected. The residual current device or circuit breaker has tripped. 	<ul style="list-style-type: none"> Connect the master switch. Restore the residual current device or circuit breaker.
Water does not reach the pasta cooker tank.	<ul style="list-style-type: none"> The waterworks gate valve is shut. 	<ul style="list-style-type: none"> Open the waterworks gate valve.a
Water does not drain from the cooking compartment.	<ul style="list-style-type: none"> The drain is clogged. 	<ul style="list-style-type: none"> Clean the drain filter. Free the drain from residues.
The inner walls of the tank are covered with limestone.	<ul style="list-style-type: none"> The water is too hard; the softener is finished. 	<ul style="list-style-type: none"> Connect the appliance to a water softener. Regenerate the water softener. Descalcify the cooking compartment.
The cooking compartment is stained.	<ul style="list-style-type: none"> Quality of the water. Ineffective detergent. Insufficient rinsing. 	<ul style="list-style-type: none"> Filter the water (see water softener). Use the recommended detergent. Rinse once again.
The gas appliance does not turn on.	<ul style="list-style-type: none"> Gas valve shut. Air inside pipes. 	<ul style="list-style-type: none"> Open the gas valve. Repeat the ignition operations.
The light indicators do not turn on.	<ul style="list-style-type: none"> The master switch is not connected. The residual current device or circuit breaker has tripped. 	<ul style="list-style-type: none"> Connect the master switch. Restore the residual current device or circuit breaker.



If the problem cannot be resolved, turn the appliance off and shut all the supply valves. Then contact authorized customer service.



5. WASTE DISPOSAL

Deactivation and scrapping of appliance



OBLIGATION OF DISPOSING OF MATERIALS USING THE LEGISLATIVE PROCEDURE IN FORCE IN THE COUNTRY WHERE THE APPLIANCE IS SCRAPPED.

In compliance with Directives (see n. 0.1 Section), relating to the reduction of use of hazardous substances in electrical and electronic equipment, as well as waste disposal. The symbol of the barred waste bin carried on the appliance or its packaging indicates that the product at the end of its useful life it must be disposed of separately from other waste.

Differentiated waste collection of this appliance at the end of its life is organised and implemented by the manufacturer. The user who wishes to get rid of this appliance must contact the manufacturer and follow the instructions received to separately dispose of the appliance at the end of its life. An appropriate collection and dispatching of exhausted appliances to environmentally compatible recycling, treatment and disposal plants helps to prevent damaging effects on health and environment and also guarantees that the component parts of exhausted appliances are effectively recycled or reused. Holders of exhausted appliances who dispose of them illegally will be prosecuted.



Specialised personnel is in charge of deactivation and scrapping of the appliance.

Waste disposal



During operation and maintenance, do not disperse pollutants (oils, grease, etc.) into the environment and perform differentiated waste disposal depending on the composition of the different materials and in compliance with relevant laws in force.

Illegal waste disposal will be prosecuted by laws in force in the territory where the violation has been ascertained.