

02/2015

# Mod: LR/325-T

Production code: 9568T



**Diamond**  
catering equipment

## COUNTERTOP HOTPLATES WITH INFRARED OVERHEAD GANTRY AND INFRARED OVERHEAD GANTRY

Art. 9564  
Art. 9566  
Art. 9568  
Art. 9570



Art. 9566

Art. 9564T  
Art. 9566T  
Art. 9568T  
Art. 9570T



Art. 9568T

## SUSPENDED INFRARED HEATED GANTRY

Art. 9566S  
Art. 9568S  
Art. 9570S



Art. 9568S

## Contents

Declaration of Conformity .....	pag.2
Introduction and Warranty .....	pag.2
Warning .....	pag.3
Warnings on the equipments .....	pag.3
Environmental Notes.....	pag.3
Purpose of the Product .....	pag.4
Technical features .....	pag.4
Installation .....	pag.5
Plate Data .....	pag.5
Functioning and use .....	pag.6
Instructions for users .....	pag.6
Maintenance and Cleaning .....	pag.6
Diagnostics and troubleshooting .....	pag.6
Electric scheme and connections .....	pag.7
Spare parts .....	pag.8

## EC Declaration of Conformity

The EC Declaration of Conformity attached to this manual refers to the serial number of the appliance. Its content complies with what is indicated below.

## EC Declaration of Conformity

The company **Metalcarrelli S.r.l.**, based in Via A. Gagliani 10/A, 47814 - Bellaria I.M. (RN) - Italy, VAT no. 03249750401, declares under the sole responsibility of its legal representative, that the following appliance:

Denomination                    COUNERTOP HOTPLATES WITH INFRARED OVERHEAD GANTRY  
AND INFRARED OVERHEAD GANTRY

Denomination                    SUSPENDED INFRARED HEATED GANTRY

Model                             \_\_\_\_\_

Serial number                    \_\_\_\_\_

Year of manufacture:            \_\_\_\_\_

is in conformity with safety requisites and with the law Directives which are enforceable to it:

- |               |   |
|---------------|---|
| 2014/35/EU    | Directive on the harmonisation of the laws of the Member States relating to the making available on the market of electrical equipment designed for use within certain voltage limits |
| 1935/2004(EC) | Regulation on materials and articles intended to come into contact with food.   |
| 2011/65/EU    | EU Directive on the restriction of the use of certain hazardous substances in electrical and electronic equipment (RoHS).   |
| 2014/30/EU    | Directive on the harmonisation of the laws of the Member States relating to electromagnetic compatibility (recast)  |

Harmonized rules used for answering to safety and health requirements:

- |                    |  |
|--------------------|--|
| EN 60335-1:2013    | Safety of Household and similar electrical appliances. - Part 1: General requirements.   |
| EN 60335-2-12:2004 | Household and similar electrical appliances. - Safety. - Part 2-12: Particular requirements for warming plates and similar appliances. |
| UNI EN 1672-2:2009 | Food processing machinery - Basic concepts - Part 2: Hygiene requirements.   |

## Introduction and Warranty

We thank you for purchasing one of our products manufactured in compliance with the strictest standards and according to technical principles aiming at ensuring an easy and safe use in professional work environments.

The manufacturer guarantees its products for 12 months, in compliance with the legislation in force.

Electrical parts and consumables are not covered under the warranty.

All interventions under warranty will be carried out at Manufacturer's premises only.

Any transport and delivery costs will be at the Customer's charge.

In order to activate the warranty, the original purchasing invoice or any other mandatory document shall be produced.

## Safety warnings



Carefully read the warnings contained in this USE AND MAINTENANCE MANUAL, as they provide important information for safe installation, use and maintenance.

Keep this manual for future reference by the operators. The manual must be kept throughout the lifetime of the equipment and must be made available to users for any reference. It is necessary to read it for any information on the installation, operation and maintenance of the equipment.

Before connecting the equipment, make sure that the data on the plate correspond to those of the electric power supply available in the place where the machine is installed.

- Periodically check the equipment for safety.
- Periodically check the equipment for its suitability for use.
- The machine must be connected to an electric socket with efficient earth connection.
- Any intervention on the equipment must be performed by qualified technicians.
- Do not touch any electric parts before disconnecting the machine from the power supply.
- Do not spill any liquids on the outer surface of the equipment and in particular near the control panel.
- Do not use the equipment with wet hands or when barefoot and standing on a wet floor.
- Do not use the equipment if the power cord is damaged.
- Do not remove the power plug by pulling the cord.
- Do not use acids or strong chemical detergents to clean the equipment.
- Children should be supervised to be sure that they do not play with the equipment.

## Warnings on the equipments



On the equipment there are the following warning labels:

- 1) ID plate indicating the serial number and the CE symbol, as per the chapter PLATE DATA. This warning is near the general switch.
- 2) Indication of the earthing node. The label is inside the equipment near the power cord inlet.

## Environmental notes

**NOISE:** The LEP,d of the equipment is less than 70 dB(A).  
If positioned in areas with a noise exposure value of more than 80 dB(A), the employer must inform and train the operator about the risks due to noise exposure and must take the necessary measures together with the competent doctor.

**PACKAGING:** The packaging materials (plastic bags, polystyrene, cardboard, etc.) must be kept away from children, because they may be dangerous. Collect and sort the materials per type (e.g. cardboard, wood, plastic materials, etc.) and dispose of them in compliance with the regulation in force.

**OUT OF SERVICE:** At the end of the equipment lifetime, disassemble and sort the components (electric board, metal frame, etc.) and dispose of them according to any local and national regulations.



Pursuant to art. 13 of the Legislative Decree no. 151 of June 25, 2005, "Enforcement of the Directives 2002/95/EC and 2003/108/EC on the restriction of the use of certain hazardous substances in electrical and electronic equipment, and on waste disposal", the equipment is considered as a "Waste Electrical and Electronic Equipment" (WEEE). The symbol shown on the left and applied on the equipment or packaging, indicates that the product cannot be disposed of as an urban waste, at the end of its lifetime, but it must be disposed separately through authorized collection centres.

The proper separate collection for further recycling, treatment and environmentally-friendly disposal of the equipment contributes to avoid any negative impact on the environment and human health and at the same time it allows to re-use and/or recycle the materials the equipment is made of.

In case of illegal disposal of the product by the owner, administrative sanctions will apply in compliance with the regulation in force.

## Intended use of the Product

The Countertop Hotplates with Infrared Overhead Gantry and the Infrared Overhead Gantres this manual refers to, are been designed and manufactured in compliance with the applicable directives and good construction standards in order to improve the maintenance of the temperature of the contained food, maintaining the quality unchanged and respecting the hygienic and safety conditions.

The Countertop Hotplates with Infrared Overhead Gantry and the Infrared Overhead Gantres shall not be used for food conservation; food shall not be left inside them after service.

## Technical features

- AISI 304 stainless steel sheet top
- Upper frame in tube and stainless steel sheet, built in and recessed to facilitate ntegration with other units
- Acrylic curved sneeze guard
- 250W infrared lamps
- Heated by electrical resistance
- Separate switches for hotplate and infrared lamps, complete with warning light
- Thermostatic control from + 30 °C to + 90 °C
- Waterproof level: IPX3
- Rubber support feet

Dati tecnici	9564	9566	9568	9570
GN capacity	1/1	2/1	3/1	4/1
Width cm	37	70	103	136
Depth cm	53	53	53	53
Height cm	65	65	65	65
Heating element W	350	650	1000	1300
Infrared lamps W	1x250	2x250	3X250	4X250
Mains supply	230 V - 1N - 50≈60 Hz			
Working temperature range	40-50 °C			

Technical data	9564T	9566T	9568T	9570T	9566S	9568S	9570S
Number lamps	1	2	3	4	2	3	4
GN Capacity	1/1	2/1	3/1	4/1	2/1	3/1	4/1
Width cm	37	70	103	136	70	103	136
Depth cm	53	53	53	53	53	53	53
Height cm	59	59	59	59	27	27	27
Infrared lamps W	1X250	2X250	3X250	4X250	2X250	3X250	4X250
Mains supply	230 V - 1N - 50≈60 Hz						

# Installation

The Countertop Hotplates with Infrared Overhead Gantry and the Suspended Heat Gantries are delivered in a single package, already assembled and ready for use. Unpack the appliance and make sure it has not suffered from damage during transport.

Remove the steel sheet protective film - if any - to prevent steel heating-up from altering the surface finish.

Connect the appliance to the electricity supply.

Before switching on the appliance:

- ensure that the voltage of your electricity supply corresponds to the data plate located in the Infrared Overhead Gantries and the Suspended Heat Gantries near the control panel;
- check that the power cable is equipped with plug

The appliance must be connected to a power socket with protection against indirect contact in compliance with the regulations in force in the country of use.



The label indicating the earth point is placed inside the heating unit, next to the power inlet.



**WARNING:**

In order to avoid any danger due to the accidental reset of the thermal switch, the appliance shall not be powered by means of an external device, such as a timer, or be connected to a circuit that is regularly powered or cut off from power supply.

## Plate Data

 				
AEE IT08020000002329				
Codice/Code				
Matricola/Serial Nr.			Anno/Year	
V	ph	Hz	W	A

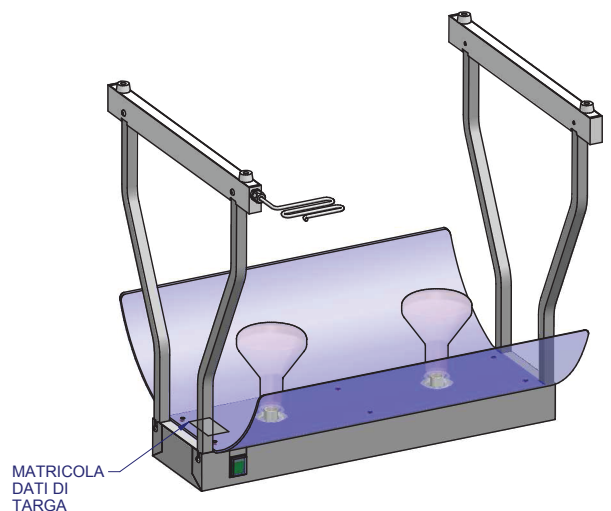
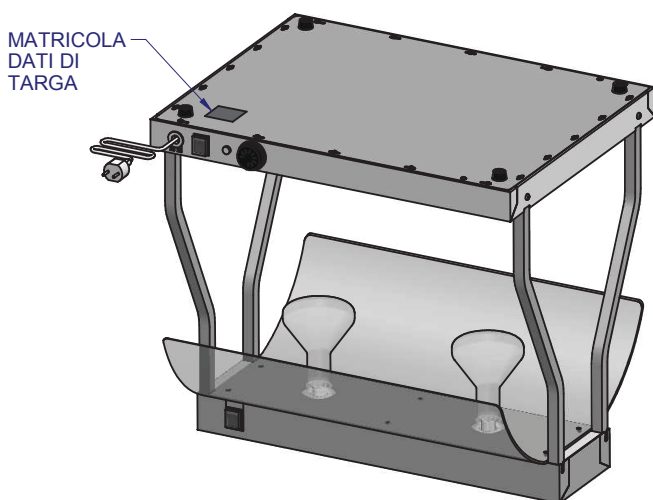

# Operation and use

Remove the protection film from any steel surfaces (if any).

Connect the power plug to a properly grounded power socket and turn the switch on.

Set the desired temperature on the thermostat.

An unpleasant odour given off when the cupboard is turned on the first time is due to residues of grease used during manufacture.

## END OF USE:

After use, switch off and disconnect the appliance from the electricity supply. **ALLOW THE APPLIANCE TO COOL DOWN** before cleaning it according to the instructions provided (see paragraph "Cleaning").

# Instructions for users



Before handling the Countertop Hotplates with Infrared Overhead Gantry and the Suspended Heat Gantries make sure that the switch is turned off, the plug is disconnected from the socket and wait for the machine to cool down. The appliance, are been designed for food distribution, ensuring the quality and hygiene conditions of food.

For this reason, it is necessary to remove the food contained in the appliance at the end of meal service and store it in suitable storage units.

If the appliance is not used for periods longer than a week, clean it thoroughly and keep in a dry place, disconnected from the electricity supply.

# Cleaning and Maintenance



Before carrying out any maintenance activity, disconnect the appliance from the electricity supply and allow to cool before starting to clean.

Any maintenance on electric components must be carried out by qualified technicians only.

## CLEANING:

Use a soft cloth and a neutral detergent Never use products like chlorine, bleach, etc., that may corrode or damage stainless steel.

Do not clean the surfaces with a steel scouring pad, brush or steel scraper.

Do not clean the appliance with a water jet.

When cleaning parts of the appliance close to the electric box, pay attention to water splashing.

## MAINTENANCE:

Before switching on the appliance, check that the power cable is not damaged. If necessary, replace it with a similar one;

## MALFUNCTIONING:

In case of failure, malfunctioning or poor performances, contact the Dealer's Technical Assistance.

Diagnostics and troubleshooting		
PROBLEM	PROBABLE CAUSES	POSSIBLE SOLUTIONS
INFRARED OVERHEAD GANTRY OR SUSPENDED INFRARED HEATED GANTRY DO NOT LIGHT UP	The lamp is burnt	Replace the lamp
THE START WARNING LAMP DOES NOT LIGHT UP	The warning light of the switch and/or the switch itself are broken	Contact the Dealer's Technical Assistance
	No power supply	Check connection to the electricity supply

# Wiring diagram and connections

- Art. 9564 = A
- Art. 9566 = A+B
- Art. 9568 = A+B+C
- Art. 9570 = A+B+C+D

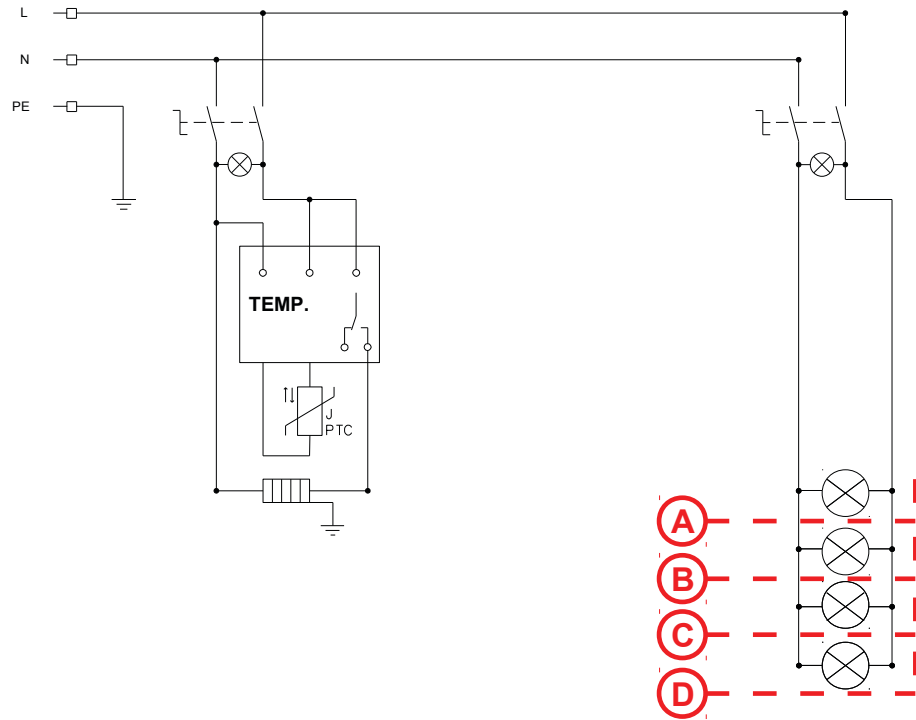

- Art. 9564T = A
- Art. 9566T = A+B
- Art. 9568T = A+B+C
- Art. 9570T = A+B+C+D+

- Art. 9566S = A+B
- Art. 9568S = A+B+C
- Art. 9570S = A+B+C+D

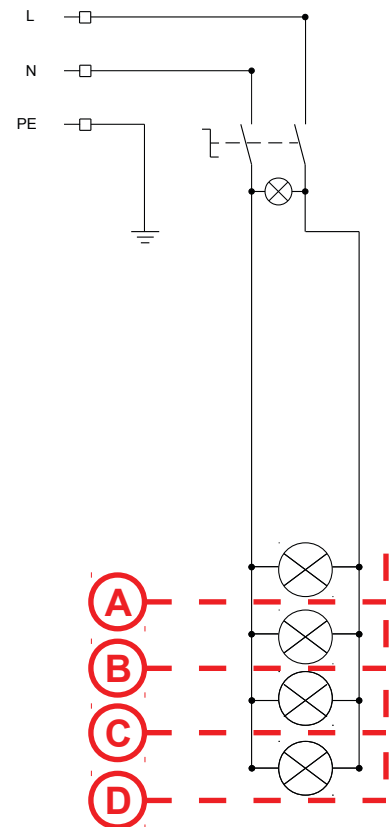



## Spare parts

Pos.	Code	Description	9564	9566	9568	9570
1	003001040023	Heating element 350 W	X			
1	003001040024	Heating element 650 W		X		
1	003001040025	Heating element 1000 W			X	
1	003001040026	Heating element 1300 W				X
2	003201820001	Thermostat	X	X	X	X
3	003252060001	Switch	X	X	X	X
4	003252060002	Switch protective cover	X	X	X	X
5	003553260005	Power cord	X	X	X	X
6	021200750003	Aluminium adhesive per sq. metre	X	X	X	X
7	001804340001	Support leg	X	X	X	X
8	233004250005	Shaped Perspex with slots	X			
8	233004250004	Shaped Perspex with slots		X		
8	233004250007	Shaped Perspex with slots			X	
8	233004250006	Shaped Perspex with slots				X
8	003151620002	Red infrared lamp - 250W	X	X	X	X
10	003151620001	Porcelain lampholder	X	X	X	X

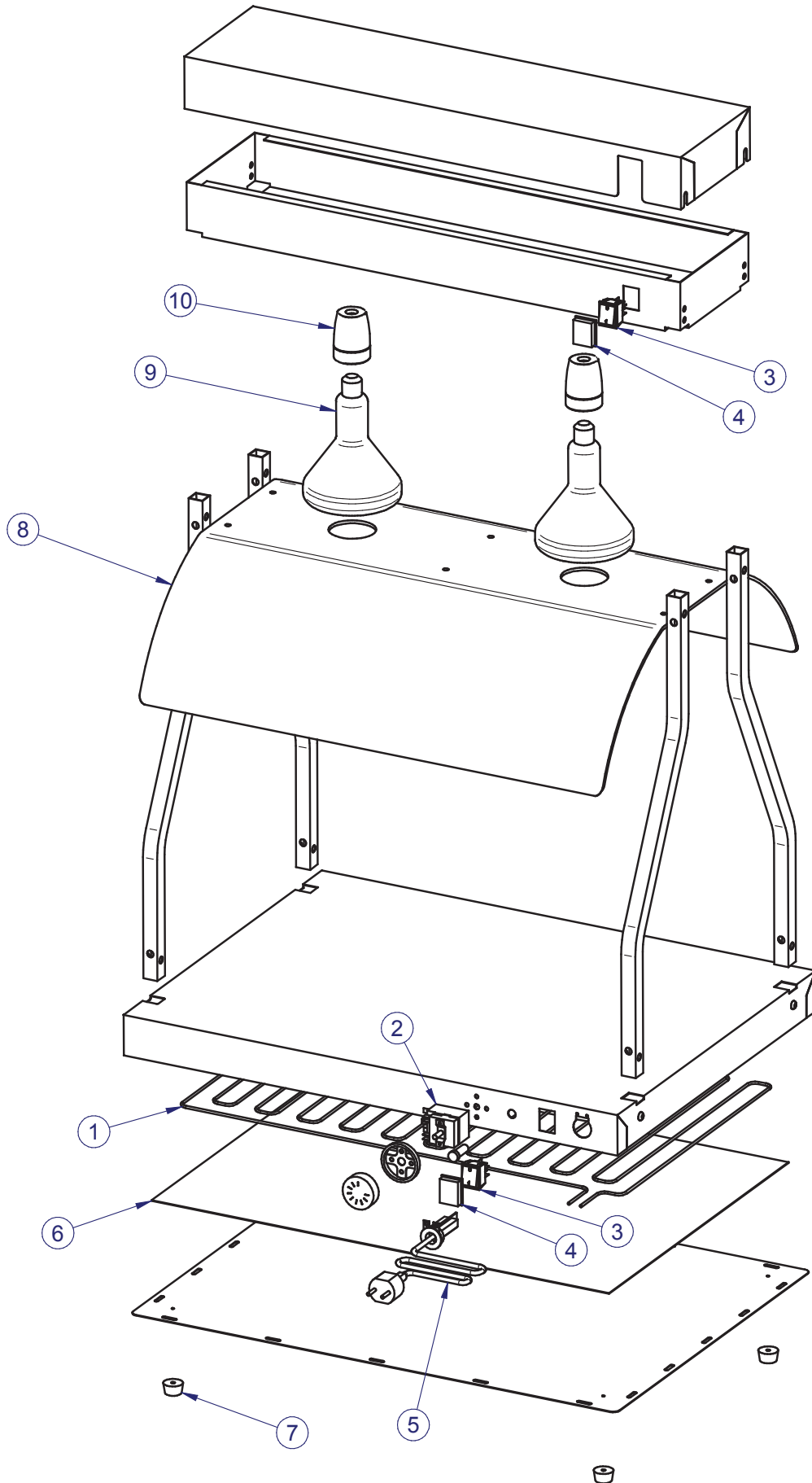

Pos.	Code	Description	9564T	9566T 9566S	9568T 9568S	9570T 9570S
1	003151620001	Porcelain lampholder	x	x	x	x
2	003151620002	Red infrared lamp - 250W	x	x	x	x
3	233004250005	rounded Perspex sneeze guard	x			
3	233004250004	rounded Perspex sneeze guard		x		
3	233004250007	rounded Perspex sneeze guard			x	
3	233004250006	rounded Perspex sneeze guard				x
4	003252060001	Switch	x	x	x	x
5	003252060002	Switch protective cover	x	x	x	x
6	021608100001	Power cord	x	x	x	x

