

02/2014

Mod: NE-1840

Production code: NE-1840



Diamond
catering equipment

Panasonic®

Operating InstructionsMicrowave Oven.....For Commercial Use
Bedienungsanleitung.....MikrowellengerätFür Gewerbliche Nutzung
Mode d'emploiFour à Micro-ondesPour Usage Professionnel
Gebruiksaanwijzing.....Magnetronoven.....Voor Professioneel Gebruik
Manual de Instrucciones ..Horno MicroondasPara Uso Commercial
Istruzioni.....Forno a MicroondePer Uso Professionale
Bruksanvisning.....MikrovågsugnFör Yrkesmässig Användning
BrugsanvisningMikrobølgeovneTil Professionelt Brug
BruksanvisningMikrobølge Ovn..For Profesjonell Bruk/Storkjøkken
KäyttöohjeetMikroaaltouuni.....Ammattikäyttöön

NE-1880/NE-3240/NE-2140/NE-1840

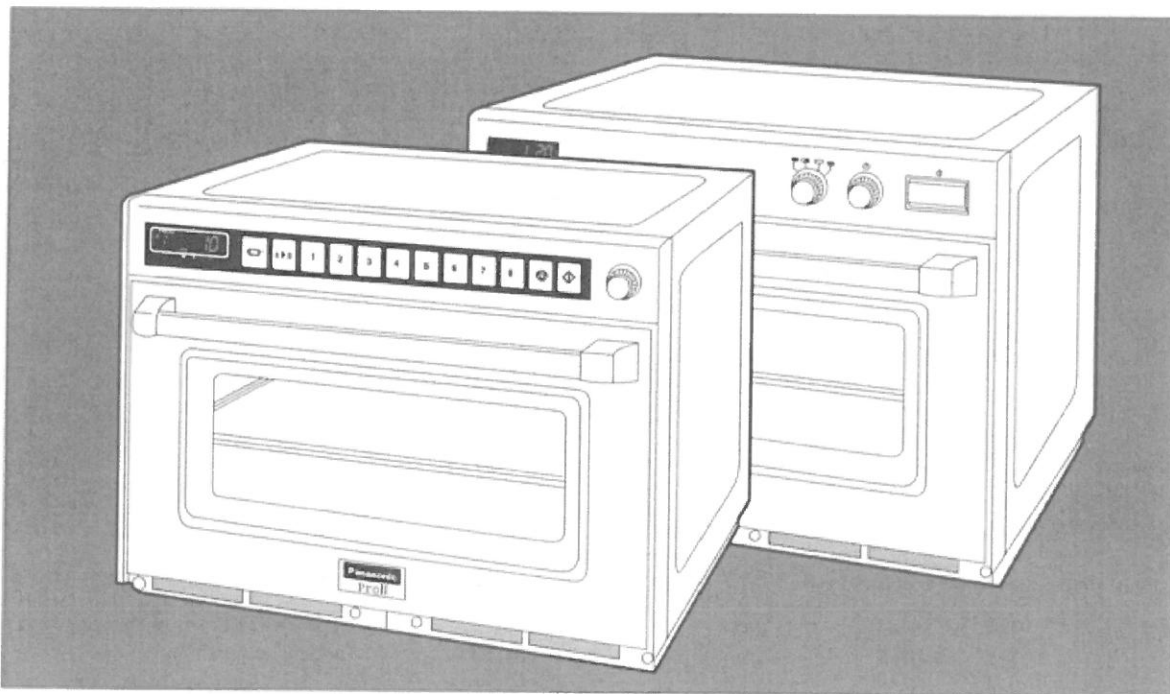

Please read these instructions completely before operating this oven and keep for future reference.
Vor Gebrauch des Gerätes bitte die Bedienungsanleitung ausführlich durchlesen.
Lire attentivement ces instructions avant toute utilisation du four. Les garder pour un usage ultérieur.
Leest U s.v.p. eerst deze handleiding in zijn geheel door, voordat U de oven in gebruik neemt.
Por favor lea atentamente el manual de instrucciones antes de utilizar este horno microondas y mantengalo accesible para futuras consultas.
Prima di utilizzare l'apparecchio, leggete attentamente queste istruzioni.
Läs instruktionerna noga innan du använder ugnen och spara dessa för framtida bruk.
Læs omhyggelig brugsanvisningen før ovnen tages i brug.
Les bruksanvisningen før ovnen benyttes, og behold den så lenge ovnen er i drift.
Lue nämä käyttöohjeet huolellisesti ennen uunin käyttöönottoa ja säilytä ne seuraavaa kertaa varten.

English

Deutsch

Français

Nederlands

Español

Italiano

Svenska

Dansk

Norsk

Suomi

<p>This product is an equipment that fulfills the European standard for EMC disturbances (EMC = Electromagnetic Compatibility) EN 55011. According to this standard this product is an equipment of group 2, class B and is within required limits. Group 2 means that radio-frequency energy is intentionally generated in the form of electromagnetic radiation for warming and cooking of food. Class B means that this product may be used in normal household areas.</p>
<p>Bei diesem Produkt handelt es sich um ein Gerät, das die europäische Norm für EMV-Funkstörungen (EMV = Elektromagnetische Verträglichkeit), EN 55011, erfüllt. Gemäß dieser Norm ist dieses Produkt ein Gerät der Gruppe 2, Klasse B und hält alle Grenzwerte ein. Gruppe 2 bedeutet, dass in diesem Gerät Hochfrequenz-Energie für das Erwärmen oder Garen von Lebensmitteln absichtlich als elektromagnetische Strahlung erzeugt wird. Klasse B sagt aus, dass dieses Produkt in einem normalen Wohnbereich betrieben werden darf.</p>
<p>Ce produit est un matériel qui répond aux normes européennes sur les perturbations électromagnétiques EMC (EMC = compatibilité électromagnétique) EN 55011. Selon cette norme, ce produit est classé Groupe 2, classe B et reste dans les limites requises. La classification groupe 2 signifie que l'énergie à fréquence radio est intentionnellement émise sous forme d'une radiation électromagnétique afin de réchauffer ou de cuire des aliments. Classe B signifie que ce produit peut être utilisé dans un environnement domestique usuel.</p>
<p>Dit produkt voldoet aan de Europese standaard (EN 55011) voor EMC interferentie 's (EMC = Elektromagnetische Compabiliteit) Overeenkomstig deze standaard behoort dit produkt tot de groep 2 apparatuur, klasse B en voldoet deze aan alle normeringseisen. Groep 2 houdt in dat de Frequentie energie wordt opgewekt in de vorm van elektromagnetische straling bedoeld voor het verwarmen en koken van voedsel. Groep B informeerd dat dit produkt toegepast kan worden voor normaal huishoudelijk gebruik.</p>
<p>Este producto es un equipo que cumple con el standard EMC (EMC = Compatibilidad Electromagnética) EN 55011. De acuerdo con este standard este producto es un equipo del grupo 2 clase B y se encuentra dentro de los límites exigidos. Grupo 2 significa que la energía de radio frecuencia es generada en forma de radiación electromagnética para calentar o cocinar alimentos. Clase B significa que este producto debe de ser usado en áreas domésticas.</p>
<p>Questo prodotto è conforme agli attuali standard Europei per la Compatibilità Elettromagnetica, in ottemperanza alle norme EN 55011. Secondo gli standard menzionati questo prodotto rientra nel gruppo 2, classe B, all'interno dei limiti richiesti. Gruppo 2; significa che la radio frequenza è generata sotto forma di emissione elettromagnetica adatta allo scopo di riscaldare o cuocere i cibi. Classe B: significa che questo prodotto può essere utilizzato nel normale ambito casalingo.</p>
<p>Denna produkt uppfyller de europeiska standard EN 55011 för EMC bestämmelser (EMC = Elektromagnetisk kompatibilitet). Enligt denna standard är denna produkt en apparat i grupp 2, klass B och uppfyller kraven för detta. Grupp 2 betyder att radio-frekvent energi produceras i form av elektromagnetiska vågor, för uppvärmning av mat. Klass B betyder att denna produkt kan användas i det normala hushållet.</p>
<p>Dette produkt opfylder den europæiske standard EN 55011 for EMC forstyrrelser (EMC = Elektromagnetisk Kompatibilitet). I henhold til denne standard er dette produkt et apparat i gruppe 2, klasse B og opfylder kravene for dette. Gruppe 2 betyder, at radio-frekevent energi dannes i form af elektromagnetiske bølger, med henblik på opvarmning af føde. Klasse B betyder, at dette produkt, må anvendes i almindelige husholdninger.</p>
<p>Dette produktet opfylder den europeiske standard EN 55011 for EMC forstyrrelser (EMC = Elektromagnetisk kompatibilitet). I henhold til denne standard er dette produkt et apparat i gruppe 2, klasse B og opfylder kravene for dette. Gruppe 2 betyr at radio-frekvent energi dannes i form av elektromagnetiske bølger, med henblik på oppvarming av mat. Klasse B betyr at dette produkt kan benyttes i almindelige husholdninger.</p>
<p>Tämä on laite, joka täyttää Eurooppalaisen EMC-standardin (EMC = Elektromagneettinen yhteensopivuus) EN 55011. Tämän standardin mukaan laite kuuluu ryhmään 2, luokkaan B ja täyttää vaadittavat ehdot. Ryhmä 2 tarkoittaa, että radioaaltoenergia syntyy elektromagneettisen säteilyn muodossa ruoan lämmittämiseksi tai kypsentämiseksi. Luokka B tarkoittaa, että tätä laitetta voidaan käyttää kotitalouksissa.</p>

Contents

Important Safety Instructions	2
Outline Diagram of NE-3240/NE-2140/NE-1840	3
How to Operate of NE-3240/NE-2140/NE-1840	
A. Manual Heating	3
B. Cycle Counter	4
C. Beep Tone	4
Outline Diagram of NE-1880	5
How to Operate NE-1880	
A. Manual Heating ..single stage heating	6
.....2 or 3 stages heating	7
B. Programmed Heating	8
C. Programming Memory pads ..single stage heating	9
.....2 or 3 stages heating	10
D. Program Lock	10-11
E. Beep Tone	11-12
F. Program List	12
G. Cycle Counter	12
Self Diagnostics Failure Code Explanation	13
Care of Your Oven	13
Cooking Instructions	
Defrosting Frozen Foods	14
Other Helpful Instructions	14
Cookware	14
Two Level Cooking	14
Microwave Basics	15
General Guidelines for Heating in a Panasonic Microwave Oven	15
Cooking Instructions — Heating and Defrosting Time Charts	16
Technical Specifications	109

Important Safety Instructions

INSTALLATION

EARTHING

IMPORTANT: FOR PERSONAL SAFETY, THIS APPLIANCE MUST BE PROPERLY EARTHED. When an outlet is not earthed, it is personal responsibility and obligation of the customer to have it replaced with a properly earthed outlet.

VOLTAGE AND POWER WARNING

The voltage used must be the same as specified on the microwave oven. Using a higher voltage than that which is specified is dangerous, and may result in a fire or other type of accident causing damage.

PLACEMENT OF THE OVEN

Locate the oven on a surface which is flat and stable. Do not place the oven in a hot or damp place; e.g. near a gas or electric range. Do not operate the oven when the room temperature is higher than 40°C (104°F) and/or the humidity is more than 85%. Free airflow around the oven is important.

There is a possibility of a small amount of interference with weak broadcast signals if the microwave oven is too close to a radio or TV.

For safe and efficient operation, the oven must have sufficient air flow to the air vents i.e. 5 cm (2 inches) at the side and rear; 20 cm (8 inches) at the top.

This microwave oven must be positioned so that the plug is accessible.

CAUTION

REMOVAL OF PROTECTIVE FILM

A protective film is used to prevent scratching of the outer case during transportation. Peel this film off before installation or use.

DO NOT TURN ON THE OVEN WHEN IT IS EMPTY.

In order to maintain the high quality of the magnetron tubes and other components, you are requested not to turn the oven on with no food inside.

DO NOT OPEN THE CABINET.

High voltages are present inside the cabinet. Repairs and adjustments should be done only by qualified service personnel.

DO NOT BLOCK THE AIR VENTS.

This microwave oven requires free airflow in the back for maximum cooling efficiency. You should keep the air vents clear while cooking.

DO NOT DRY CLOTHES IN THE OVEN.

Do not dry clothes in the microwave oven since there is a possibility of the clothes burning if left in the oven for too long of a time.

ATTACH CAUTION LABEL.

Before using this appliance, a suitable caution label must be attached. Please select appropriate label provided and attach to top of appliance.

WARNING

1. The door seals and door seal areas should be cleaned with a damp cloth.
2. The appliance should be inspected for damage to the door seals and door seal areas and if these areas are damaged the appliance should not be operated until it has been repaired by service technician trained by the manufacturer.
3. It is dangerous for anyone other than a service technician trained by the manufacturer to perform repair service.
4. If smoke is observed, press Stop/Reset pad and keep door closed. Disconnect the power cord, or shut off power at the fuse or circuit breaker panel.
5. If the supply cord is damaged, it must be replaced by the manufacturer or its service agent or a similarly qualified person in order to avoid a hazard.
6. Before use, the user should check that utensils are suitable for use in the microwave ovens.
7. When heating liquids, e.g. soup, sauces and beverages in your microwave oven, overheating the liquid beyond boiling point can occur without evidence of bubbling. This could result in a sudden boil over the hot liquid. To prevent this possibility the following steps should be taken:
 - a) Avoid using straight-sided containers with narrow necks.
 - b) Do not overheat.
 - c) Stir the liquid before placing the container in the oven and again halfway through cooking time.
 - d) After heating, allow to stand in the oven for a short time, stirring again before carefully removing the container.
8. When heating food in plastic or paper containers, check the oven frequently due to the possibility of ignition.
9. The contents of feeding bottles and baby food jars are to be stirred or shaken. The temperature has to be checked before consumption to avoid burns.
10. Liquids or other foods must not be heated in sealed containers since they are liable to explode.
11. Eggs in their shell and whole hard-boiled eggs should not be heated in microwave ovens since they may explode.
12. Microwave heating of beverages can result in delayed eruptive boiling, therefore care has to be taken when handling the container.
13. Only allow children to use the oven without supervision when adequate instructions have been given so that the child is able to use the oven in a safe way and understands the hazards of improper use.
14. **Removable Shelf**
Do not slide the removable middle shelf in or out when placing or removing food. This action could cause damage to the shelf or cause hot food to tip towards the operator.
15. The rear panel can become hot—take care when handling.



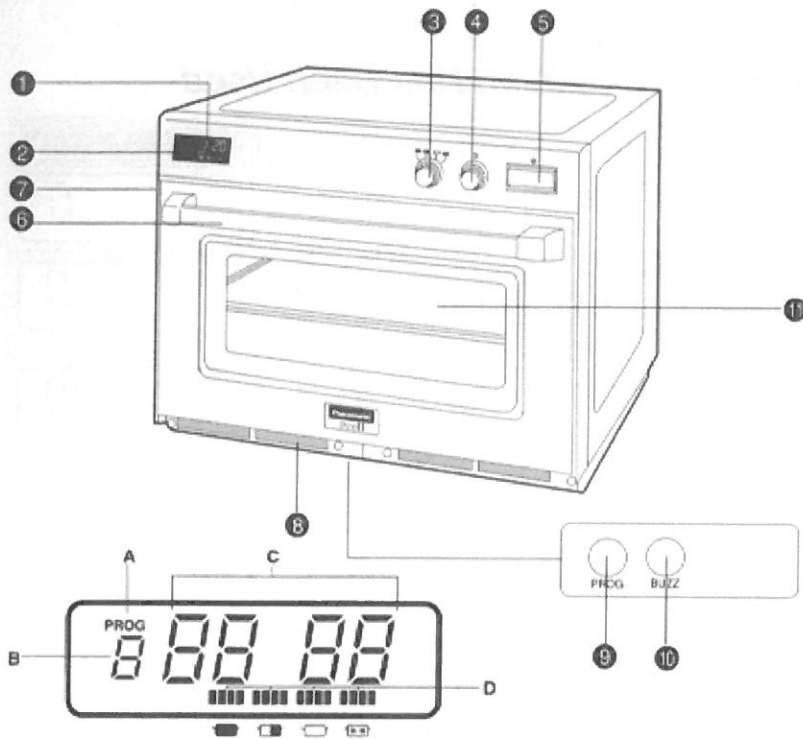

Outline Diagram and Operation of NE-3240/NE-2140/NE-1840

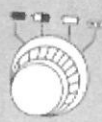

- ① Digital Display Window
 - ② Power Level Indicator Display
 - ③ Power Level Selector Dial
 - ④ Timer Dial
 - ⑤ Start Button
 - ⑥ Door Handle
 - ⑦ Oven Lamp Cover
 - ⑧ Air Filters
 - ⑨ Program Entry Switch (behind Air Filter)
 - ⑩ Buzzer Switch (behind Air Filter)
 - ⑪ Middle Shelf
- A - Program Display
 B - Beep Tone Mode Display
 C - Heating Time Display (min. sec.)
 D - Power Level Indicator
- HIGH
 - MEDIUM
 - LOW
 - ⊞ DEFROST

A. MANUAL HEATING

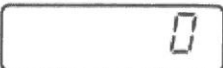

Example: To cook food at HIGH power for 2 minutes

PAD	INSTRUCTION	DIGITAL DISPLAY WINDOW
1	Open the door and put the food in the oven. ☛ The oven lamp will turn on. "0" and Power Level Indicator ■ will appear.	
2	 Select the desired Power Level by turning the Power Level Selector Dial.	
3	 Set the desired heating time. ☛ Please check the heating time will appear. Note: up to 60 minutes.	
4	 Press Start Button. ☛ The oven lamp will turn on and heating will start. Power Level Indicator will start to blink, and heating time will count down.	
<ul style="list-style-type: none"> • At the end of the time, the beep tone will sound and all heating will stop. The oven lamp will go off. 1 minute later the cooling fan will stop. The display will blink "0" until the door is opened. • Open the door and take the food out. "0" will appear in the display window and the Power Level will be displayed. The oven lamp will be turned on. • Close the door. The oven lamp will go off and 1 minute later the display window will go blank. • When you press the Start Button with door open, "0" will appear in the display in all cases. • Even after setting the heating time you can still change the power level. • If you wish to change the heating time during heating, simply adjust the timer to desired minutes and seconds. The microwave oven can also be turned OFF by turning the Timer Dial to the left until "0" appears in the digital display and beep tone can be heard. 		  

How to Operate of NE-3240/NE-2140/NE-1840





B. CYCLE COUNTER

◆ To Read Total Cumulative Times That The Oven Has Been Used

	PAD	INSTRUCTION	DIGITAL DISPLAY WINDOW
1		Open the door. The oven lamp will be turned on. ☛ "0" will appear in the display.	0
2		Close the door. NOTE: Carry out Step 3 within 60 seconds of closing the door, or the display will go blank.	0
3	 + 	While pressing Buzzer Switch, press Program Entry Switch. Example: 99999 times	9 99 99

C. BEEP TONE

◆ To Cancel Beep

	PAD	INSTRUCTION	DIGITAL DISPLAY WINDOW
1		Press Program Entry Switch. (The door may be open or closed at this stage.)	PROG
2		Press Buzzer Switch. ☛ "bEEP" and first stage heating indicator "1" will appear in Digital Display Window.	PROG 1 bE EP
3		Press Buzzer Switch again. ☛ "0 bEEP" will appear in Digital Display Window.	PROG 0 bE EP
4		Press Program Entry Switch again. ☛ "PROG" will stop blinking. You have completed setting silent level.	PROG 0 bE EP

Outline Diagram of NE-1880

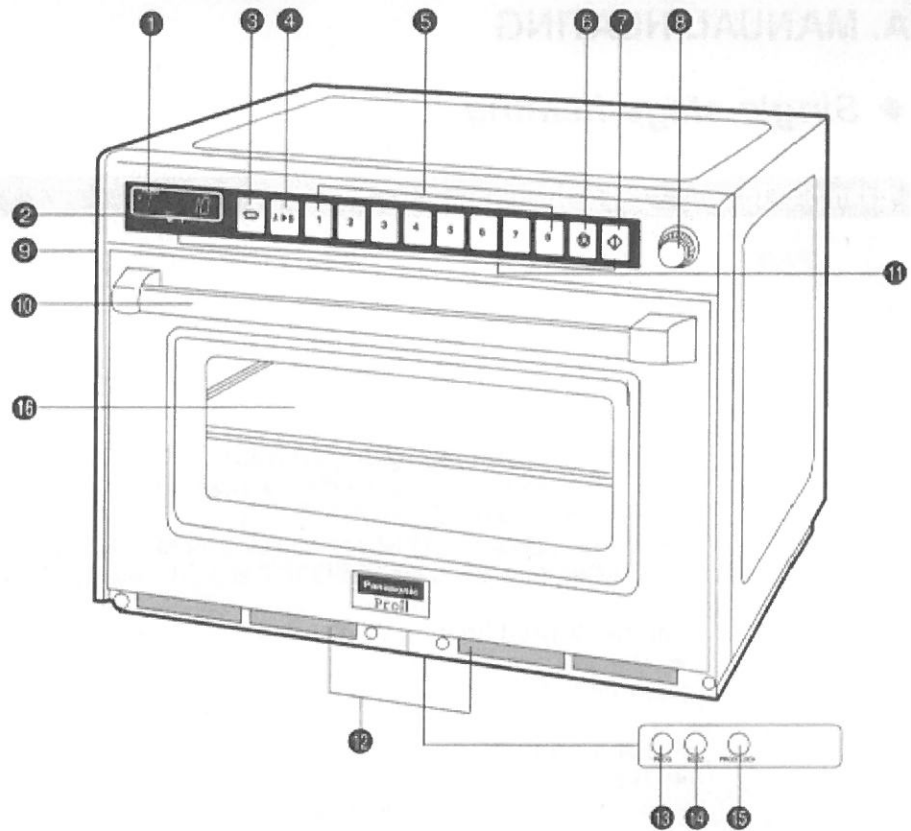

- ① Digital Display Window
- ② Power Level Indicator Display
- ③ Power Level Selector Pad (□)
- ④ Memory Shift Pad (...)
- ⑤ Memory Pads
- ⑥ Stop/Reset Pad (Ⓢ)
- ⑦ Start Pad (⏩)
- ⑧ Timer Dial
- ⑨ Oven Lamp Cover
- ⑩ Door Handle
- ⑪ Control Panel
- ⑫ Air Filters
- ⑬ Program Entry Switch (behind Air Filters)
- ⑭ Buzzer Switch (behind Air Filters)
- ⑮ Program Lock Switch (behind Air Filters)
- ⑯ Middle Shelf

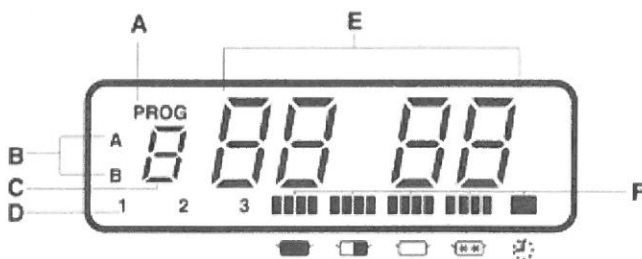

- A - Program Display
- B - Memory Area Code Display
- C - Memory Pad Number Display
- D - Stage Heating Indicator
- E - Heating Time Display (min. sec.)
- F - Power Level Indicator

- HIGH
- MEDIUM
- LOW
- Ⓢ DEFROST
- ⏩ STAND

This oven is preset at the factory for the following:

- ◆ Manual operation
- ◆ Memory pads preset HIGH power at the indicated heating times for single stage heating

1 = 10 sec.	2 = 20 sec.	3 = 30 sec.	4 = 45 sec.	5 = 1 min.
6 = 1 min. 15 sec.	7 = 1 min. 30 sec.	8 = 2 min.		

 (There are two sides, A and B. Only A-side is preset.)

- ◆ Program Unlock
- ◆ Cycle Counter set to "0" on all pads











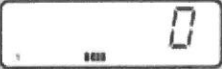

If you wish to change these times, please consult the operating instructions to find how to program them.

How to Operate NE-1880

A. MANUAL HEATING

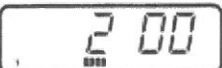
◆ Single stage heating

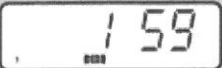
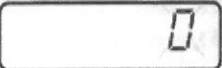
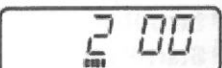
Example: To cook food at HIGH power for 2 minutes

	PAD	INSTRUCTION	DIGITAL DISPLAY WINDOW
1		Open the door and put the food in the oven. ☛ The oven lamp will turn on and "0" will appear. Note: While "0" appears, operation is available. One minute after the door is closed, "0" will disappear.	
2		Press Power Level Selector pad once. ☛ The selected power level will be indicated and 1st Stage Heating Indicator "1" will start to blink. Note: Press once for HIGH power, twice for MEDIUM power, 3 times for LOW, four times for DEFROST and 5 times for STAND.	
3		Set the desired heating time using the Timer Dial. ☛ The selected heating time will appear. Note: up to 15 min. on  or  , 60 min. on  ,  or 	
4		Press Start pad. ☛ The oven lamp will turn on and heating will start. Power Level Indicator will start to blink, and heating time will count down.	
<ul style="list-style-type: none"> • When all time expires, beep tone will sound and heating will stop. The oven lamp will turn off. "0" will blink until the door is opened. One minute later, cooling fan will stop. • Open the door and take the food out. The oven lamp will turn on. Digital Display Window will show the originally selected time and power. • Close the door. The oven lamp will turn off. One minute later, Digital Display Window will go blank. 			  

How to Operate NE-1880

◆ 2 or 3 stages heating

Example: To cook food at HIGH power for 2 minutes and at DEFROST power for 1 minute

PAD	INSTRUCTION	DIGITAL DISPLAY WINDOW
	Follow steps 1 to 3 on page 6.	
4	Press Power Level Selector pad four times. ☛ The selected power level will be indicated and 2nd Stage Heating Indicator "2" will start to blink.	
5	Set the desired heating time for the second stage using the Timer Dial. ☛ The set heating time will appear. Note: up to 15 min. on or , 60 min. on , or	
6	Press Start pad. ☛ The oven lamp will turn on. The total time for both stages will appear and start to count down. 1st Stage Heating Indicator "1" and Power Level Indicator for the first stage heating will start to blink.	
<ul style="list-style-type: none"> • After the first stage heating, a single beep tone will sound. 2nd Heating Stage Indicator "2" and Power Level Indicator for the second stage heating will start to blink and the remaining heating time will count down. • When all time expires, beep tone will sound and heating will stop. The oven lamp will turn off. "0" will blink until the door is opened. One minute later, cooling fan will stop. • Open the door and take the food out. The oven lamp will turn on. Digital Display Window will show the originally set time and power. • Close the door. The oven lamp will turn off. One minute later, Digital Display Window will go blank. 		

Note: For 3 stages Heating, repeat steps 4 and 5 above before pressing Start pad .

SPECIAL NOTE: For both single and 2 or 3 stages heating

1. While heating, one press on Stop/Reset pad stops the operation. You can restart it by pressing Start pad or a second press on Stop/Reset pad will cancel the selected program.
2. While not heating, one press on Stop/Reset pad cancels the selected program.
3. You can repeat exactly the same manually selected heating time by pressing only Start pad , if you use the oven again within one minute (within 30 minutes when the door has been left open).
4. One minute later of non-use with door closed, the repeat feature will be cancelled.







How to Operate NE-1880

B. PROGRAMMED HEATING

◆ In Program Unlock Mode:

MAKE SURE THE UNIT IS PROPERLY PROGRAMMED (see page 9).

Example: To select Memory pad "5" at A side in which your desired heating program (at HIGH power for 3 min., single stage heating) is set

	PAD	INSTRUCTION	DIGITAL DISPLAY WINDOW
1		Open the door and put the food in the oven. ☛ The oven lamp will turn on and "0" will appear. Note: While "0" appears, operation is available. One minute after the door is closed, "0" will disappear.	
2		Press the Desired Memory Pad "5". ☛ The currently programmed information will be indicated.	
3		Press Start pad. ☛ The oven lamp will turn on and heating will start. The heating time will count down.	
<ul style="list-style-type: none"> • When all time expires, beep tone will sound and heating will stop. The oven lamp will turn off. "0" will blink until the door is opened. One minute later, cooling fan will stop. • Open the door and take the food out. The oven lamp will turn on. • Close the door. The oven lamp will turn off. One minute later, Digital Display Window will go blank. 			 

Note:

- When you want to select Memory Area B, press Memory Shift pad  before pressing the desired Memory pad.

◆ In Program Lock Mode:

Just press the desired Memory pad. Heating will automatically start without pressing Start pad.











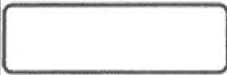

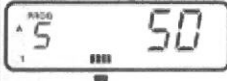

How to Operate NE-1880

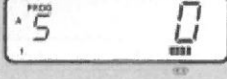
C. PROGRAMMING MEMORY PADS

◆ Single stage heating

THE OVEN CAN NOT BE PROGRAMMED WHEN PROGRAM LOCK IS ACTIVATED! (see page 10 - 11)
DO NOT OPEN THE DOOR WHILE PROGRAMMING!

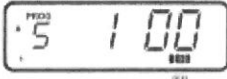
Example: To program cooking at DEFROST power for 1 minute into Memory pad "5"

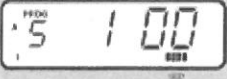
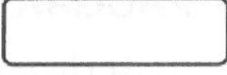
PAD	INSTRUCTION	DIGITAL DISPLAY WINDOW
1	Keep the door closed. • Digital Display Window must be blank or show "0".	
2	 Press Program Entry Switch. • "PROG" will start to blink.	
3	 Press Memory pad you wish to program. • The selected pad number will appear and currently programmed information will be indicated.	
4	 Press Power Level Selector pad four times. • The selected power level will be indicated, "PROG" and 1st Stage Heating Indicator "1" will start to blink.	
5	 Set the desired heating time using Timer Dial. • The set heating time will appear. Note: up to 15 min. on  or  , 60 min. on  ,  or 	
6	 Press Program Entry Switch again. • "PROG" and 1st Stage Heating Indicator "1" will stop blinking. This means that you have completed programming.	
• Three seconds later, Digital Display Window will go blank.		











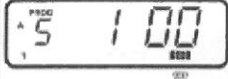

- Note:**
- Program the remaining Memory pads as desired by repeating steps 2-6 above.
 - When you want to select Memory Area B, press Memory Shift pad  before selecting the desired Memory pad.

How to Operate NE-1880

◆ 2 or 3 stages heating



**THE OVEN CAN NOT BE PROGRAMMED WHEN PROGRAM LOCK IS ACTIVATED! (see page 10 - 11)
DO NOT OPEN THE DOOR WHILE PROGRAMMING!**

Example: To program cooking at DEFROST power for 1 minute and at HIGH power for 2 minutes into Memory pad "5"

PAD	INSTRUCTION	DIGITAL DISPLAY WINDOW
	Follow steps 1 to 5 on page 9.	
6 	Press Power Level Selector pad once. • The power level for 2nd stage will be indicated, 2nd Stage Heating Indicator "2" will start to blink.	
7 	Set the desired heating time using Timer Dial. • The set heating time will appear. Note: up to 15 min. on  or  , 60 min. on  ,  or 	
8 	Press Program Entry Switch again. • "PROG" and 2nd Stage Heating Indicator "2" will stop blinking. The total time for both stages will appear. This means that you have completed programming.	
• Three seconds later, Digital Display Window will go blank.		

D. PROGRAM LOCK

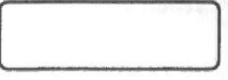
◆ To Activate Program Lock:



PAD	INSTRUCTION	DIGITAL DISPLAY WINDOW
1	Keep the door closed. • Digital Display Window must be blank.	
2 	Press Program Lock Switch until "PROG", "P" and "L" appear. (for five seconds) • "PROG", "P" and "L" will appear.	

In Program Lock mode:

- The oven is started by pressing the desired Memory pad. There is no need to press Start pad.
- Opening the door cancels the remaining time on the program.
- The oven can not be programmed until the program lock is released.

How to Operate NE-1880

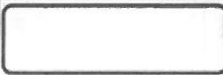
◆ To Release Program Lock:

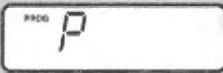
PAD	INSTRUCTION	DIGITAL DISPLAY WINDOW
1	Keep the door closed. • Digital Display Window must be blank.	
2	 Press Program Lock Switch until "PROG" and "P" appear. (for five seconds) • "PROG" and "P" will appear.	





In Program Unlock mode:

- Oven reverts to a two-touch operating mode (Memory pad + Start pad).
- Repeat and interrupt feature are operational.
- Memory pads can be programmed.
- Tone loudness control and length control are operational.

E. BEEP TONE

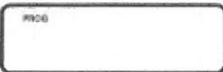
The loudness of beep tone and the length of beep tone at the end of heating cycle can be set. There are four levels of the loudness. There are two options of the length of beep tone at the end of heating cycle. The loudest level and 3 beeps are preset at the factory.

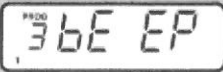
◆ To Select Loudness Level and Length "3 beeps":

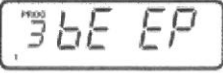
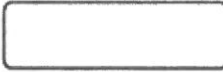
PAD	INSTRUCTION	DIGITAL DISPLAY WINDOW
1	 Press Program Entry Switch. • "PROG" sign will start to blink in the display window. (The door may be open or closed at this stage)	
2	 Press Buzzer Switch. • The tone will sound at its loudness level and the loudness level "3" followed by the word "bEEP" will appear. "PROG" will start to blink and 1st Stage Heating Indicator "1" (the length of beep tone "3 beeps") will be indicated. Note: Repeating to press Buzzer Switch will lower the loudness level all the way to silent. (3bEEP — loudest, 2bEEP — middle, 1bEEP — quietest, and 0bEEP — silent)	
3	 Press Program Entry Switch again. • "PROG" will stop blinking. That means that you have completed program. Three seconds later, the display window will go blank when the door is closed.	 

How to Operate NE-1880

◆ To Select Length of Tone "short beeps for 60 seconds":

PAD	INSTRUCTION	DIGITAL DISPLAY WINDOW
4	Follow step 1-3 on page 11.	
5 	Within three seconds after pressing Program Entry Switch at step 3, press Buzzer Switch. ☛ "PROG" will start to blink and 2nd Stage Heating Indicator "2" (the length of beep tone "short beeps for 60 seconds") will be indicated.	
6 	Press Program Entry Switch again. ☛ "PROG" will stop blinking. This means that you have completed programming. Three seconds later, the display window will go blank when the door is closed.	

F. PROGRAM LIST

PAD	INSTRUCTION	DIGITAL DISPLAY WINDOW
1	Open the door and leave it open. ☛ The oven lamp will turn on and "0" will appear.	
2 +	While pressing Stop/Reset pad, press Start pad. ☛ All currently programmed information (the program set into each Memory pad (A/B sides), Beep Tone, and Program Lock information) will continuously appear.	

G. CYCLE COUNTER

◆ To Read Total Cumulative Times That The Oven Has Been Used:

PAD	INSTRUCTION	DIGITAL DISPLAY WINDOW
1	Open the door and leave it open. ☛ The oven lamp will turn on and "0" will appear.	
2	Close the door. ☛ Carry out Step 3 within 60 seconds of closing the door, or the display will go blank.	
3 +	While pressing Buzzer Switch, press Program Entry Switch. ☛ The display shows the total cumulative number of times the oven has been used.	

Self Diagnostics Failure Code Explanation

This oven monitors its operation and displays a Failure Code in the display window when a problem occurs.

What to do when a failure code appears:

CODE	CAUSE	WHAT TO DO
F01	<ul style="list-style-type: none"> • Overcooked food. • Temperature of exhaust air too high. 	<ul style="list-style-type: none"> • Unplug the appliance to stop beep. • Wait for appliance to cool down to reset operation. • If food ignites, do not open the door. • If normal operation does not resume, call the service agent with information of failure code.
F05	• Defective Memory IC.	<ul style="list-style-type: none"> • Unplug the appliance and wait more than 1 minute and reconnect. • If normal operation does not resume, call the service agent with information of failure code.
F33-34	• Defective thermistor circuit.	
F44	• Defective control panel.	
F81-F84 F86-F89	• Defective relay circuit.	

Note: Above codes shown in the display do not indicate all the possible failures on the unit.

Care of Your Oven

1. Disconnect the appliance from the electricity supply before cleaning.
2. Keep the inside of the oven clean. If pieces of food or spilled liquids stick to the oven walls, or between door seal and door surface, they will absorb microwaves and may cause arcing or sparks. Wipe up all spills with a damp cloth. Kitchen detergent may be used if the oven gets very dirty. Do not use harsh detergents or abrasives.
3. The outside surface of this Microwave Oven should be cleaned with soap and water, then dried with a soft cloth. Make sure that water does not get into the back ventilation opening since this can damage the unit.
4. The window of the door should be washed with very mild soap and water. Be sure to use a soft cloth. Never use window cleaner. The door front can be scratched by harsh soap or cleaners.

Cleaning the Air Filters

Clean the Air Filters occasionally according to the following instructions. Problems may occur with the oven if the filters become clogged with dirt or dust.*

1. Remove the right Air Filter from the front bottom skirt by pulling the Right Pop Pin straight out. Then slide the filter to the right and lift it off the post at the centre. Remove the left Air Filter the same as right one.
 2. Wash the filters with soap and water.
 3. To replace, align the filter with the center post, and holding the front of the Pop Pin forward, located the back of the pin into its hole. Press the front of the pin and it will pop into place. Be sure to replace the air filters before using this oven.
- * If the Air Filter becomes clogged with dust or grease this will cause an overheat problem on the oven.

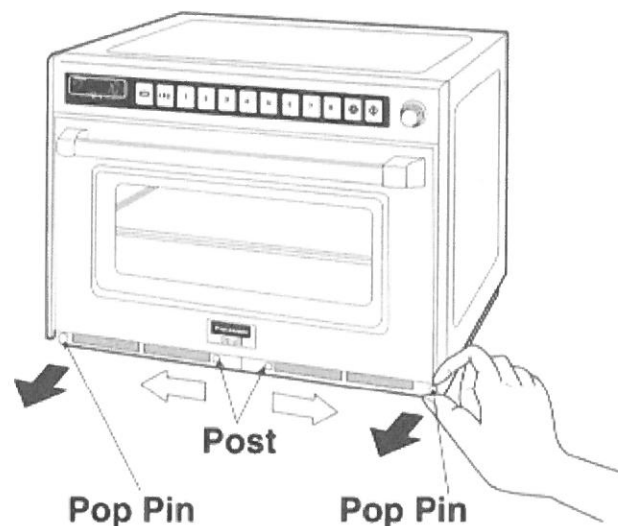

Cooking Instructions

DEFROSTING FROZEN FOODS

1. If you try to completely defrost frozen food in the Microwave Oven, uneven defrosting may occur due to the differences in the thickness and shape of the food. In actual usage of frozen food, you should not normally defrost them 100%, 70% defrosting in the Microwave Oven is ideal and helpful for the next cooking operation.
2. To defrost evenly, turn the food 180°, or turn it over during defrosting.
3. To defrost fatty meat, heat it in the Microwave Oven for a short time and leave it to stand at room temperature, or heat it intermittently until defrosted.
4. When you defrost a whole chicken, or any frozen food of irregular shape, wrap legs or thin parts with aluminum foil. Otherwise thin parts will be defrosted faster and sometimes cooked before other parts have properly defrosted.
5. Ice should be removed at times during defrosting.

OTHER HELPFUL INSTRUCTIONS

For best results

1. When determining time for a particular food, always calculate the minimum time and check occasionally during cooking for progress. The Microwave Oven cooks so quickly, it is easy to overcook your food.
2. Be careful of the cooking time for small quantities of food, or food with low water content. They may burn if cooked too long.
3. Do not use the oven for drying kitchen towels or napkins. They may burn if heated too long.
4. Do not try to boil eggs in the oven.
5. When you cook an egg be sure to pierce the yolk membrane prior to placing into the oven to prevent the egg bursting.

How to get a browned finish

Generally food does not brown when cooked by a Microwave Oven. This is one of the features of the equipment. To brown foods such as chicken, brush sauce on the surface or sprinkle with microwave browning powder before or during cooking. You can also brown meat in a conventional frying pan before cooking in the oven.

For even finished cooking

Open the door and give the dish a half turn, or turn the food over during cooking. This helps to achieve more even cooking.

COOKWARE

1. Before using the oven always check that containers are suitable. **DO NOT MICROWAVE** sealed containers as they may explode.
N.B. Always check manufacturer's instructions as some food manufacturers are producing food in containers that do not require piercing.
2. **DO NOT** leave the appliance unattended if paper, plastic or other combustible containers are used. Do not use re-cycled paper products, as they may contain impurities which may cause sparks and/or fires when used, unless packaging states they are specifically designed for **MICROWAVE** use.
3. Heat-proof glassware, such as Pyrocream and Pyrex, is best suited for use in the Microwave Oven.
4. Do not use metal ware, ceramics trimmed with gold or silver, or any container with a metal content.
5. If "arcing" should occur, check the cookware carefully again for metal.
6. You may use ordinary glassware, chinaware, plastic-ware and paper-ware, when cooking food that requires a low temperature. Using this type of cookware for high temperature cooking may cause cracking or warping.

CAUTION

Do not use **METAL UTENSILS** in this oven.

TWO LEVEL COOKING

When heating, one item always place the container in the centre of the base shelf.

When using the microwave mainly for reheating one item at a time, remove the shelf and work on the base plate.

When reheating two items at a time place both dishes on the base shelf side by side, unless the containers are too large and then place one on each shelf.

When heating more than two plates, place the dishes evenly on the two shelves.

Allow some space between each plate, do not cram too much food into the oven.

When defrosting or cooking in the oven, only work on the bottom shelf, do not use the two shelves simultaneously.

MICROWAVE BASICS

Fundamental principles determine the success of microwave food preparation.

They include:

1. **TEMPERATURE OF FOODS** — Frozen or refrigerated food items will require longer heating times to reach a desired serving temperature than foods from room temperature.
2. **FOOD COMPONENTS** — Foods high in sugar, salt, fats and moisture content heat faster because these properties attract microwave energy. Denser foods high in protein and fiber, absorb microwave energy slower which means a lengthier heating time.
3. **BULK/VOLUME** — The greater the mass of food, the longer it takes to heat.
4. **CONTAINERS** — Ceramic, paper, china, styrofoam, glass and plastic are suitable for use in microwave ovens with the following caution.

Heating foods with either high sugar or high fat content should be done **ONLY** in high temperature-resistant containers since these foods get very hot. Using styrofoam containers for these foods will cause the styrofoam to warp. Other low temperature restaurant glass or plastic platters may crack or warp under similar conditions.

DO NOT HEAT foods in a **SEALED** container or bag. Foods expand when heated and can break the container or bag.

5. **AVOID METAL** because it "bounces" the microwaves, causing uneven heating and sometimes even flashes, which may pit or mark the interior of the oven, the metal container or plate trim.
6. Heated liquids can erupt if not mixed with air. Do not heat liquids in your microwave oven without first stirring.

GENERAL GUIDELINES FOR HEATING IN A PANASONIC MICROWAVE OVEN

For specific time, see each food category for appropriate heating techniques, plus necessary pre-preparation of foods.

HEATING FOODS FROM REFRIGERATED TEMPERATURE

Foods stored in the refrigerator (5°C) should be covered before reheating with the exception of breads, pastries or any breaded product, which should be heated uncovered to prevent sogginess.

Most conventionally prepared foods should be slightly undercooked, and held in the refrigerator, so that overcooking does not occur during microwave heating.

Cooked items, such as vegetables, may be portion plated and covered for reheating without loss of color, texture or nutritional content.

HEATING FOODS FROM ROOM TEMPERATURE

Food items such as canned entree, vegetables, etc. will require significantly less heating time than those from refrigerated temperatures.

IMPORTANT RECOMMENDATIONS

1. For best results it is recommended that foods conventionally prepared be slightly undercooked when subsequently heated in this oven.
2. **REMEMBER** that after the heating cycle has been completed, internal food temperatures continue to rise slightly in foods heated in this oven.
3. A major abuse of microwave applications is the category of breads, pastries and pies. They are drier than insides or fillings, they heat more slowly. Therefore, baked goods should **ONLY** be heated until the crust is warm to the touch (50°C-55°C).
4. **DO NOT OVERHEAT YOUR FOOD:** 99% of all food quality complaints of microwave heated foods can be traced to overheating.

Cooking Instructions — Heating and Defrosting Time Charts —

The times given in the chart below are a **guideline only**. Many factors eg **starting temperature** of the food can affect the final heating time required. The cooking and defrosting times must be adjusted when necessary. All times are tested using foods at **starting temperatures** as below;

Chilled foodsApprox. +5°C

Frozen foodsApprox. -18°C

Always check for the correct core temperature with a temperature probe to comply with current Government Food Hygiene Regulations.

Function	Food	Weight	Power Level	Approx. Time		
				NE-3240	NE-2140	NE-1880/1840
Defrosting	Fish Fillets	500 g	☞	6 min 40 s	6 min 40 s	8 min
	Minced Beef	500 g	☞	4 min 15 s	4 min 15 s	5 min
	Whole Chicken	1.36 kg	☞	21 min 15 s	21 min 15 s	25 min
	Composite Dish					
	Multi portion	1.36 kg	☞	17 min	17 min	20 min
	Single portion	275 g	☞	6 min 40 s	6 min 40 s	8 min
	Apple Pie	1 portion	☞	1 min 05 s	1 min 05 s	1 min 15 s
	Gateau	1 portion	☞	1 min 40 s	1 min 40 s	2 min
Bread Rolls	1 portion 50 g	☞	25 s	25 s	30 s	
Cooking from Chilled Raw Food	Scrambled Egg	2 eggs + 2 tbsp. milk	☞	13-17 s	22-25 s	26-30 s
	Broccoli	500 g	☞	1 min 40 s	3 min	3 min 30 s
	Fish Fillets	500 g	☞	2 min 20 s	4 min	4 min 45 s
	Bacon	2 rashers	☞	25 s	40 s	50 s
	Chicken Portions	500 g	☞	2 min 30 s	6 min	7-8 min
				-3 min 25 s	-6 min 50 s	
Cooking and/or Reheating from Frozen	Peas	500 g	☞	2 min 10 s	3 min 25 s	4 min
	Cooked Rice	167 g	☞	1 min	1 min 25 s	1 min 40 s
	Cooked Sausages	x 3 (50 g each)	☞	40 s	50 s	1 min
	Cooked Wings of Fire	x 7 pieces	☞	1 min	1 min 25 s	1 min 40 s
	Cooked Boxed Cheeseburger	75 g	☞	40 s	50 s	1 min
	Chocolate Fudge Cake	1 portion	☞	25 s	25 s	30 s
Reheating from Cooked Chilled	Lasagne	325 g	☞	1 min 40 s	2 min 30 s	3 min
	Chilli	325 g	☞	1 min 40 s	2 min 30 s	3 min
	Apple Pie	1 portion	☞	8 s	14 s	16 s
	Pepper Sauce	100 ml	☞	35 s	40 s	50 s
	Baked Beans	100 ml	☞	35 s	40 s	50 s
	Soup	125 ml	☞	26 s	40 s	50 s

- HINTS:**
- Do not cook/reheat/defrost directly onto the base of the oven — use a suitable container.
 - When defrosting **multi portions** of foods, turn over and break apart halfway through defrost time to allow better penetration of microwave energy.
 - **Solid/dense foods** should not be cooked from frozen as they will be overcooked round the edges before the centre has reached the required temperature.
 - **Cover** dishes where appropriate during cooking/reheating. This will retain moisture and prevent splashing/spillages.
 - Loosen lids/pierce clingfilm before cooking/reheating covered foods.
 - **Stir** or **shake** foods halfway through cooking/defrosting time to distribute the heat evenly.
 - Allow a **Stand Time** before food temperature is checked and/or offered for consumption.

Technical Specifications

	NE-1880/NE-1840	NE-2140	NE-3240
Power source	50 Hz. 230 V	50 Hz. 2N 400 V	50 Hz. 2N 400 V
Required power	15.0 A 3200 W	9.5 A 3650 W	12.9 A 4960 W
Output	<ul style="list-style-type: none">  HIGH 1800 W*  MEDIUM 900 W  LOW 340 W  DEFROST 170 W 	<ul style="list-style-type: none">  HIGH 2100 W*  MEDIUM 1050 W  LOW 340 W  DEFROST 170 W 	<ul style="list-style-type: none">  HIGH 3200 W*  MEDIUM 1600 W  LOW 340 W  DEFROST 170 W
Frequency	2450 MHz	2450 MHz	2450 MHz
Outer dimensions (W×D×H)	650×526×471 mm	650×526×471 mm	650×526×471 mm
Cavity dimensions (W×D×H)	535×330×250 mm	535×330×250 mm	535×330×250 mm
Net weight	54 kg	54 kg	65 kg

*IEC Test Procedure

Specifications subject to change without notice.

As for the production month, country and serial no., please refer to the name plate on the microwave oven.



Technische Daten

	NE-1880/NE-1840	NE-2140	NE-3240
Netzspannung	50 Hz/230 V	50 Hz/2N 400 V	50 Hz/2N 400 V
Leistungsaufnahme	15,0 A 3200 W	9,5 A 3650 W	12,9 A 4960 W
Ausgangsleistung	<ul style="list-style-type: none">  maximale 1800 W*  halbe Leistung 900 W  niedrige Leistung 340 W  Auftaustufe 170 W 	<ul style="list-style-type: none">  maximale 2100 W*  halbe Leistung 1050 W  niedrige Leistung 340 W  Auftaustufe 170 W 	<ul style="list-style-type: none">  maximale 3200 W*  halbe Leistung 1600 W  niedrige Leistung 340 W  Auftaustufe 170 W
Frequenz/Mikrowelle	2450 MHz	2450 MHz	2450 MHz
Außenabmessungen (B×T×H)	650×526×471 mm	650×526×471 mm	650×526×471 mm
Garraumabmessungen (B×T×H)	535×330×250 mm	535×330×250 mm	535×330×250 mm
Nettogewicht	54 kg	54 kg	65 kg

*IEC Test Verfahren

Technische Änderungen ohne besondere Mitteilung vorbehalten.

Caractéristiques techniques

	NE-1880/NE-1840	NE-2140	NE-3240
Source d'alimentation	monophasé 50 Hz, 230 V	50 Hz, 2N 400 V	50 Hz, 2N 400 V
Puissance absorbée	15,0 A 3200 W	9,5 A 3650 W	12,9 A 4960 W
Puissance utile	<ul style="list-style-type: none">  FORT 1800 W*  MOYEN 900 W  DOUX 340 W  DECONGELATION 170 W 	<ul style="list-style-type: none">  FORT 2100 W*  MOYEN 1050 W  DOUX 340 W  DECONGELATION 170 W 	<ul style="list-style-type: none">  FORT 3200 W*  MOYEN 1600 W  DOUX 340 W  DECONGELATION 170 W
Fréquence	2450 MHz	2450 MHz	2450 MHz
Dimensions extérieures (L×P×H)	650×526×471 mm	650×526×471 mm	650×526×471 mm
Dimensions intérieures (L×P×H)	535×330×250 mm	535×330×250 mm	535×330×250 mm
Poids net	54 kg	54 kg	65 kg

*Normes IEC

Technische gegevens

	NE-1880/NE-1840	NE-2140	NE-3240
Electrische voeding	50 Hz, 230 V	50 Hz, 2N 400 V	50 Hz, 2N 400 V
Opgenomen vermogen	15,0 A 3200 W	9,5 A 3650 W	12,9 A 4960 W
Afgegeven vermogen	<input type="checkbox"/> HOOG 1800 W* <input type="checkbox"/> MIDDEN 900 W <input type="checkbox"/> LAAG 340 W <input type="checkbox"/> ONTDOOIEN 170 W	<input type="checkbox"/> HOOG 2100 W* <input type="checkbox"/> MIDDEN 1050 W <input type="checkbox"/> LAAG 340 W <input type="checkbox"/> ONTDOOIEN 170 W	<input type="checkbox"/> HOOG 3200 W* <input type="checkbox"/> MIDDEN 1600 W <input type="checkbox"/> LAAG 340 W <input type="checkbox"/> ONTDOOIEN 170 W
Frequentie (microgolven)	2450 MHz	2450 MHz	2450 MHz
Buitenafmetingen (breedte×diepte×hoogte)	650×526×471 mm	650×526×471 mm	650×526×471 mm
Oven afmetingen (breedte×diepte×hoogte)	535×330×250 mm	535×330×250 mm	535×330×250 mm
Netto gewicht	54 kg	54 kg	65 kg

*IEC testprocedure

Características técnicas

	NE-1880/NE-1840	NE-2140	NE-3240
Suministro eléctrico	monofásico 50 Hz, 230 V	50 Hz, 2N 400 V	50 Hz, 2N 400 V
Potencia necesaria	15,0 A 3200 W	9,5 A 3650 W	12,9 A 4960 W
Potencia de salida	<input type="checkbox"/> ALTA 1800 W* <input type="checkbox"/> MEDIA 900 W <input type="checkbox"/> BAJA 340 W <input type="checkbox"/> DESC. 170 W	<input type="checkbox"/> ALTA 2100 W* <input type="checkbox"/> MEDIA 1050 W <input type="checkbox"/> BAJA 340 W <input type="checkbox"/> DESC. 170 W	<input type="checkbox"/> ALTA 3200 W* <input type="checkbox"/> MEDIA 1600 W <input type="checkbox"/> BAJA 340 W <input type="checkbox"/> DESC. 170 W
Frecuencia	2450 MHz	2450 MHz	2450 MHz
Medidas exteriores (ancho×fondo×alto)	650×526×471 mm	650×526×471 mm	650×526×471 mm
Medidas del horno (ancho×fondo×alto)	535×330×250 mm	535×330×250 mm	535×330×250 mm
Peso	54 kg	54 kg	65 kg

*método de prueba según la norma IEC

Caratteristiche tecniche

	NE-1880/NE-1840	NE-2140	NE-3240
Alimentazione	1 fase 50 Hz, 230 V	50 Hz, 2N 400 V	50 Hz, 2N 400 V
Potenza richiesta	15,0 A 3200 W	9,5 A 3650 W	12,9 A 4960 W
Potenza di uscita	<input type="checkbox"/> ALTA 1800 W* <input type="checkbox"/> MEDIA 900 W <input type="checkbox"/> BASSA 340 W <input type="checkbox"/> SCONGELAMENTO 170 W	<input type="checkbox"/> ALTA 2100 W* <input type="checkbox"/> MEDIA 1050 W <input type="checkbox"/> BASSA 340 W <input type="checkbox"/> SCONGELAMENTO 170 W	<input type="checkbox"/> ALTA 3200 W* <input type="checkbox"/> MEDIA 1600 W <input type="checkbox"/> BASSA 340 W <input type="checkbox"/> SCONGELAMENTO 170 W
Frequenza	2450 MHz	2450 MHz	2450 MHz
Dimensioni esterne (L×P×A)	650×526×471 mm	650×526×471 mm	650×526×471 mm
Dimensioni del forno (L×P×A)	535×330×250 mm	535×330×250 mm	535×330×250 mm
Peso netto	54 kg	54 kg	65 kg

*Misurata secondo norme IEC

Tekniska data

	NE-1880/NE-1840	NE-2140	NE-3240
Elanslutning	50 Hz, 230 V	50 Hz, 2N 400 V	50 Hz, 2N 400 V
Effekt	15,0 A 3200 W	9,5 A 3650 W	12,9 A 4960 W
Utgångseffekt	<input type="checkbox"/> HÖG 1800 W* <input type="checkbox"/> MEDEL 900 W <input type="checkbox"/> LÅG 340 W <input type="checkbox"/> UPPTINING 170 W	<input type="checkbox"/> HÖG 2100 W* <input type="checkbox"/> MEDEL 1050 W <input type="checkbox"/> LÅG 340 W <input type="checkbox"/> UPPTINING 170 W	<input type="checkbox"/> HÖG 3200 W* <input type="checkbox"/> MEDEL 1600 W <input type="checkbox"/> LÅG 340 W <input type="checkbox"/> UPPTINING 170 W
Frekvens	2450 MHz	2450 MHz	2450 MHz
Ytermått (B×D×H)	650×526×471 mm	650×526×471 mm	650×526×471 mm
Ugnens innermått (B×D×H)	535×330×250 mm	535×330×250 mm	535×330×250 mm
Vikt	54 kg	54 kg	65 kg

*IEC testprocedur

Tekniske specifikationer

	NE-1880/NE-1840	NE-2140	NE-3240
Strømforsyning	50 Hz, 230 V	50 Hz, 2N 400 V	50 Hz, 2N 400 V
Strømforbrug	15,0 A 3200 W	9,5 A 3650 W	12,9 A 4960 W
Effekt	<input type="checkbox"/> HØJ 1800 W* <input type="checkbox"/> MELLEM 900 W <input type="checkbox"/> LAV 340 W <input type="checkbox"/> OPTØNING 170 W	<input type="checkbox"/> HØJ 2100 W* <input type="checkbox"/> MELLEM 1050 W <input type="checkbox"/> LAV 340 W <input type="checkbox"/> OPTØNING 170 W	<input type="checkbox"/> HØJ 3200 W* <input type="checkbox"/> MELLEM 1600 W <input type="checkbox"/> LAV 340 W <input type="checkbox"/> OPTØNING 170 W
Frekvens	2450 MHz	2450 MHz	2450 MHz
Ydre mål (B×D×H)	650×526×471 mm	650×526×471 mm	650×526×471 mm
Indvendige mål (B×D×H)	535×330×250 mm	535×330×250 mm	535×330×250 mm
Netto vægt	54 kg	54 kg	65 kg

*IEC test procedure

Tekniske data

	NE-1880/NE-1840	NE-2140	NE-3240
Nettilkobling	50 Hz, 230 V	50 Hz, 2N 400 V	50 Hz, 2N 400 V
Effektkrav	15,0 A 3200 W	9,5 A 3650 W	12,9 A 4960 W
Ytelser	<input type="checkbox"/> HØY 1800 W* <input type="checkbox"/> MIDDELS 900 W <input type="checkbox"/> LAV 340 W <input type="checkbox"/> TINING 170 W	<input type="checkbox"/> HØY 2100 W* <input type="checkbox"/> MIDDELS 1050 W <input type="checkbox"/> LAV 340 W <input type="checkbox"/> TINING 170 W	<input type="checkbox"/> HØY 3200 W* <input type="checkbox"/> MIDDELS 1600 W <input type="checkbox"/> LAV 340 W <input type="checkbox"/> TINING 170 W
Frekvens	2450 MHz	2450 MHz	2450 MHz
Utvendige mål (b×d×h)	650×526×471 mm	650×526×471 mm	650×526×471 mm
Innvendige mål (b×d×h)	535×330×250 mm	535×330×250 mm	535×330×250 mm
Nettvekt	54 kg	54 kg	65 kg

*IEC Testprosedyre

Tekniset tiedot

	NE-1880/NE-1840	NE-2140	NE-3240
Verkköjännite	50 Hz. 1 fase 230 V	50 Hz. 2N 400 V	50 Hz. 2N 400 V
Tehontarve	15,0 A 3200 W	9,5 A 3650 W	12,9 A 4960 W
Kuumennusteho	<ul style="list-style-type: none"> ☐ TÄYSITEHO 1800 W* ☐ PUOLITEHO 900 W ☐ PIENITEHO 340 W ☐ SULATUS 170 W 	<ul style="list-style-type: none"> ☐ TÄYSITEHO 2100 W* ☐ PUOLITEHO 1050 W ☐ PIENITEHO 340 W ☐ SULATUS 170 W 	<ul style="list-style-type: none"> ☐ TÄYSITEHO 3200 W* ☐ PUOLITEHO 1600 W ☐ PIENITEHO 340 W ☐ SULATUS 170 W
Taajuus	2450 MHz	2450 MHz	2450 MHz
Ulkomitat (leveys×syvyys×korkeus)	650×526×471 mm	650×526×471 mm	650×526×471 mm
Uunin mitat (leveys×syvyys×korkeus)	535×330×250 mm	535×330×250 mm	535×330×250 mm
Paino	54 kg	54 kg	65 kg

*IEC testausmenetelmä

