

12/2019

Mod: SG15B/A1-R2

Production code: SG150PSSG003H

SAIGON SG

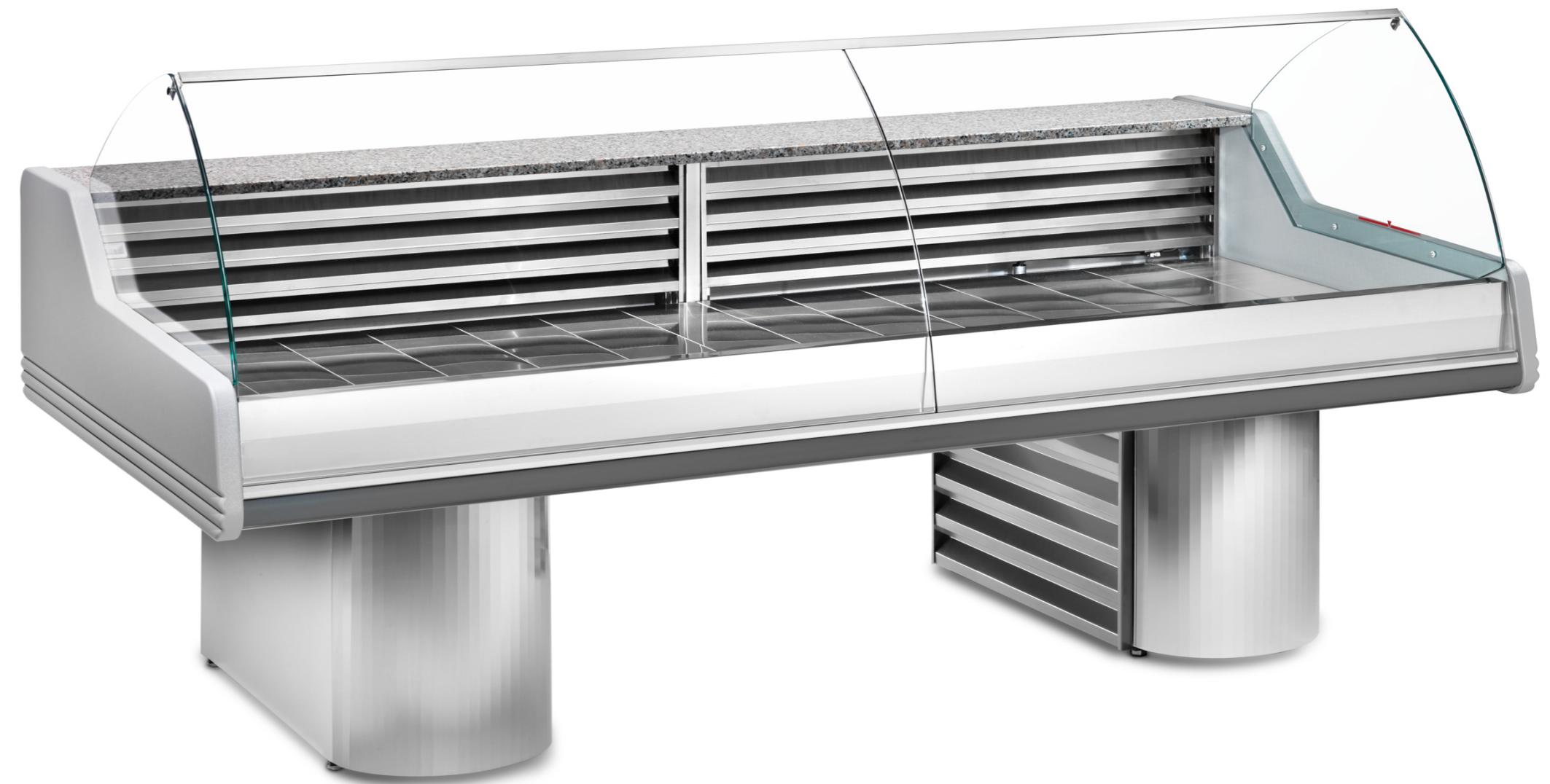
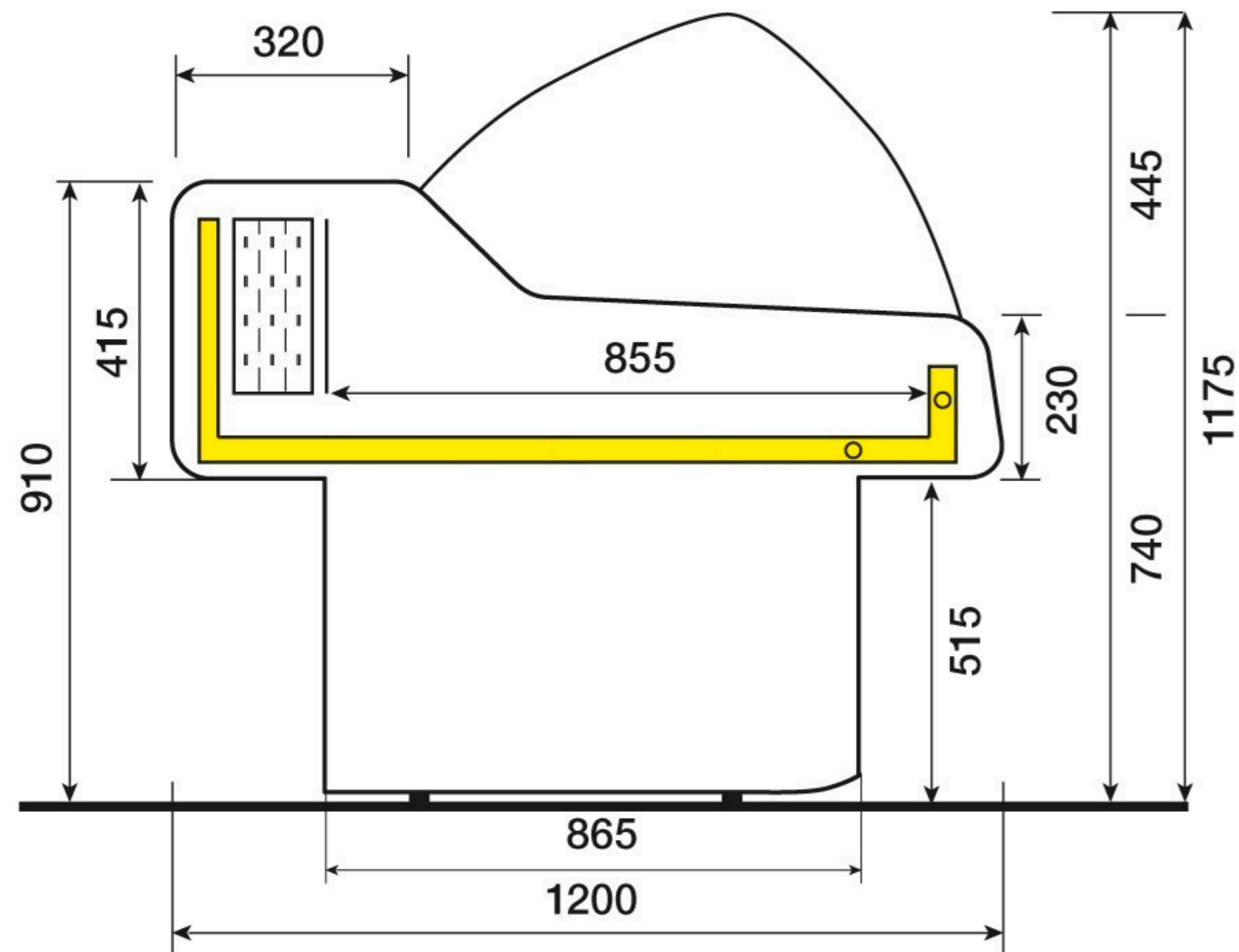

MODELLO	LUNG. LENGTH LAENGE LONGUEUR	MOTORE COMPRESSOR KOMPRESSOR COMPRESSEUR	ILLUMINAZIONE LIGHTING BELEUCHTUNG ILLUMINATION	QUANTITA' GAS GAS QUANTITY GAS MENGE QUANTITE' DE GAS (KG.)	TIPO DI GAS KIND OF GAS GAS-TYP TIPE DE GAZ	HP	Potenza frigorifera Refrigeration power Kaltleistung Puissance frigorifique Watt (-10°C)	Watt assorbiti Watt absorbed Nennleistungsaufnahme Watts absorbés	Assorbimento Ventilatori Fab absorption Luefteraufnahmen Absorption ventilateurs (W)	TUBI TUBES RÖHREN TUBES (mm)	
SG	STATICO - STATISCH - STATIC - STATIQUE - ESTATICA									<i>S</i>	<i>D</i>
	150	NEU6210GK	/	0,100	R 290	1/2	690	373	/	8	6
	200	NEK6213GK	/	0,115	R 290	1/2+	873	537	/	8	6
	250	NEU6217GK	/	0,130	R 290	3/4+	1115	550	/	8	6
	300	NT6222GK	/	0,150	R 290	1-	1358	845	/	10	6
	350	J9226GK	/	1,200	R 404	1+	1648	1258	/	10	6

S= ASPIRAZIONE - SUCTION - ASPIRATION - SAUG
D= MANDATA (PER VALVOLA) - DISCHARGE - DECHARGE - DRUCK

I dati delle unità si riferiscono alla versione con gruppo incorporato. Per la versione gruppo a distanza il calcolo deve essere fatto dal frigorista.
The data of the units refer to the version with built-in unit. For the version with remote unit, the calculation has to be made by the technician.
Die Angaben des Kühlaggregats sind für die Ausführung mit eingebautem Aggregat. Für die Ausführung mit externem Aggregat die Kalkulation muss vom Kälte-Techniker gemacht werden.
Les données du groupe sont pour la version avec groupe incorporé. Pour la version avec groupe à distance le calcul doit être fait par le frigoriste.

Modello: SG	Revisione: 00
Codice: SG	Data: 27-08-2018

I dati tecnici possono essere soggetti a cambiamenti senza alcun obbligo di preavviso. We reserve the right to change technical features without notice. Technische aenderungen sind ohne voranzeige moeglich. Nous nous reservons le droit de varier sans preavis les details techniques.

SAIGON SG

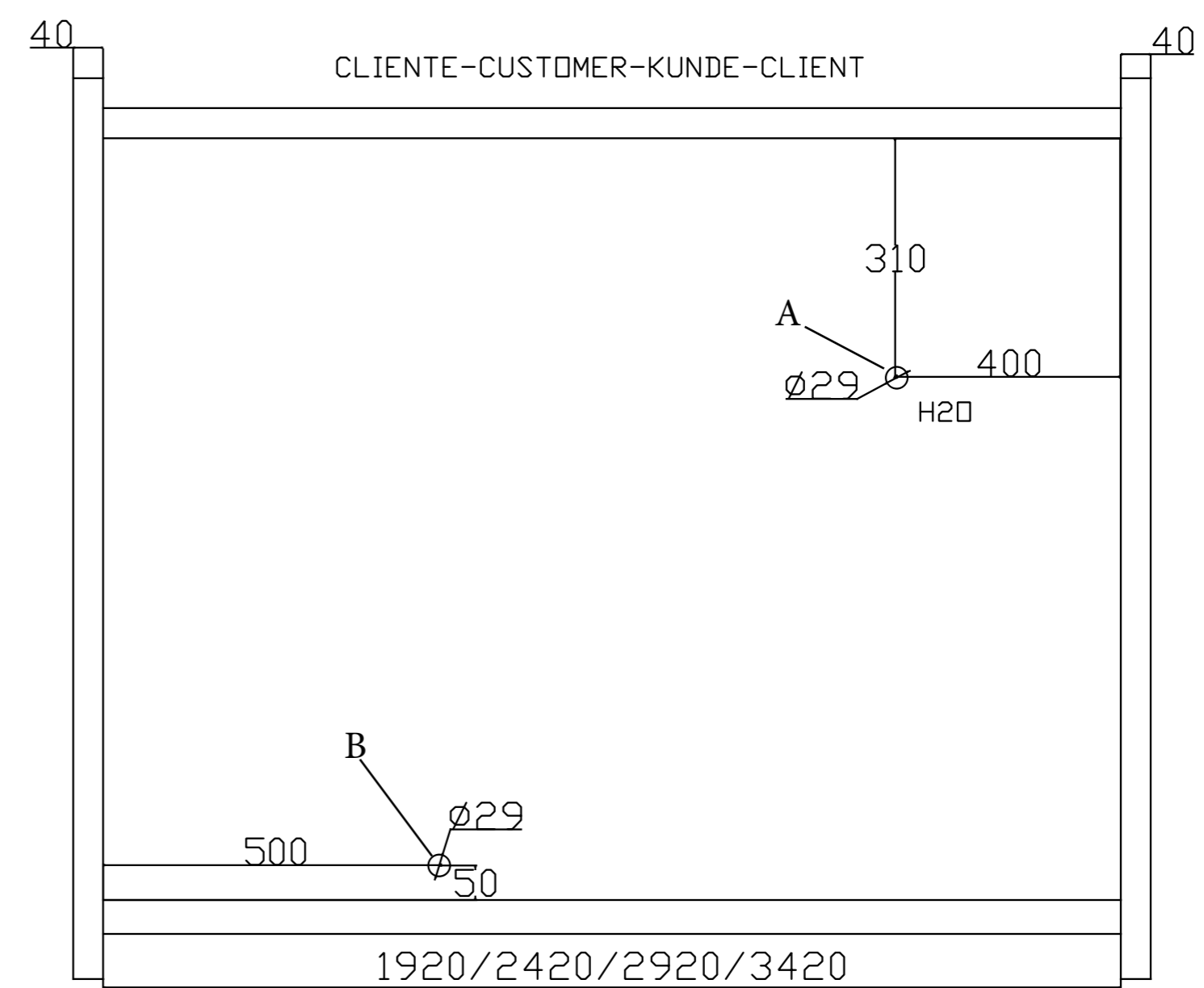
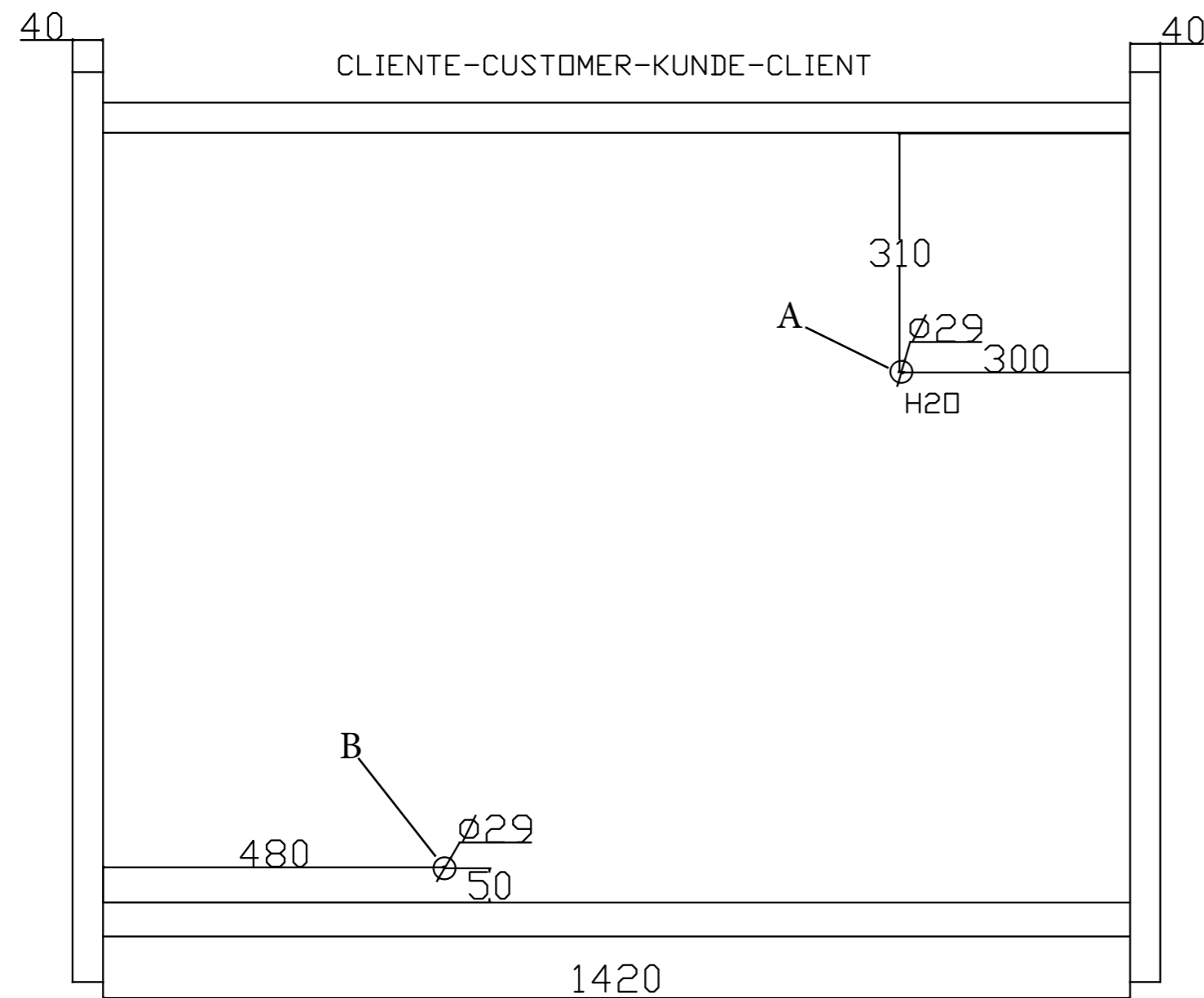
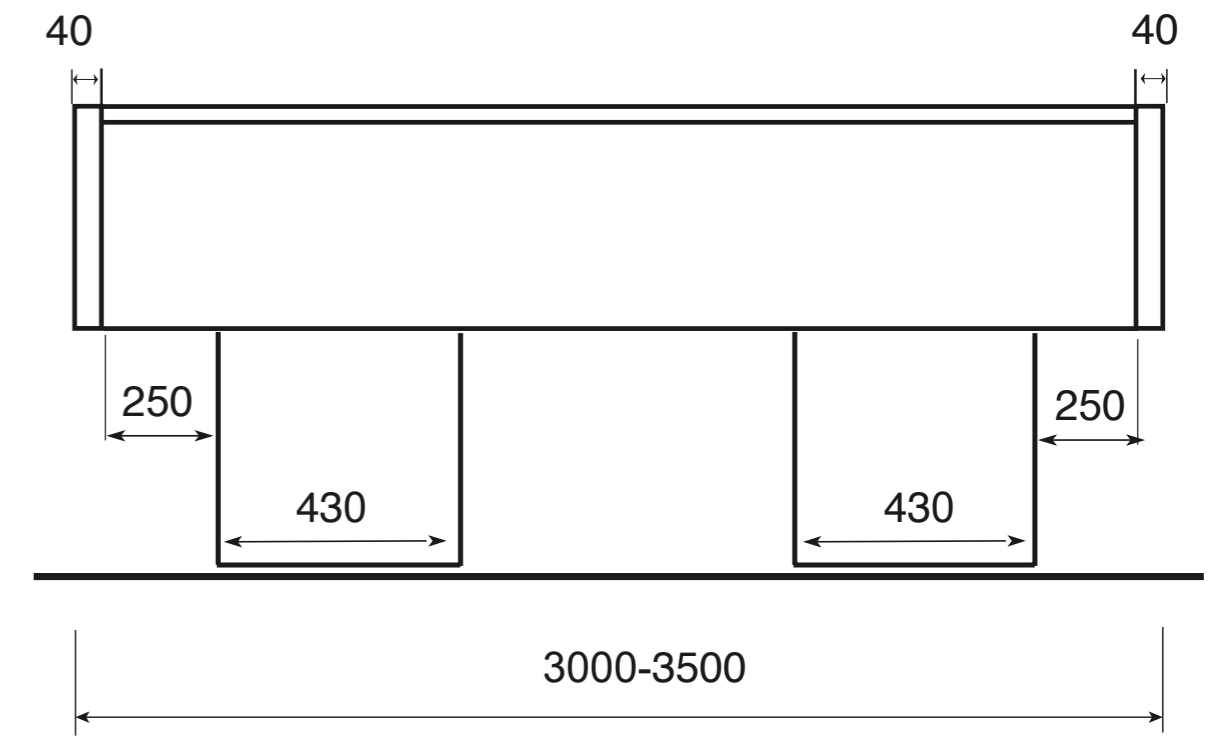
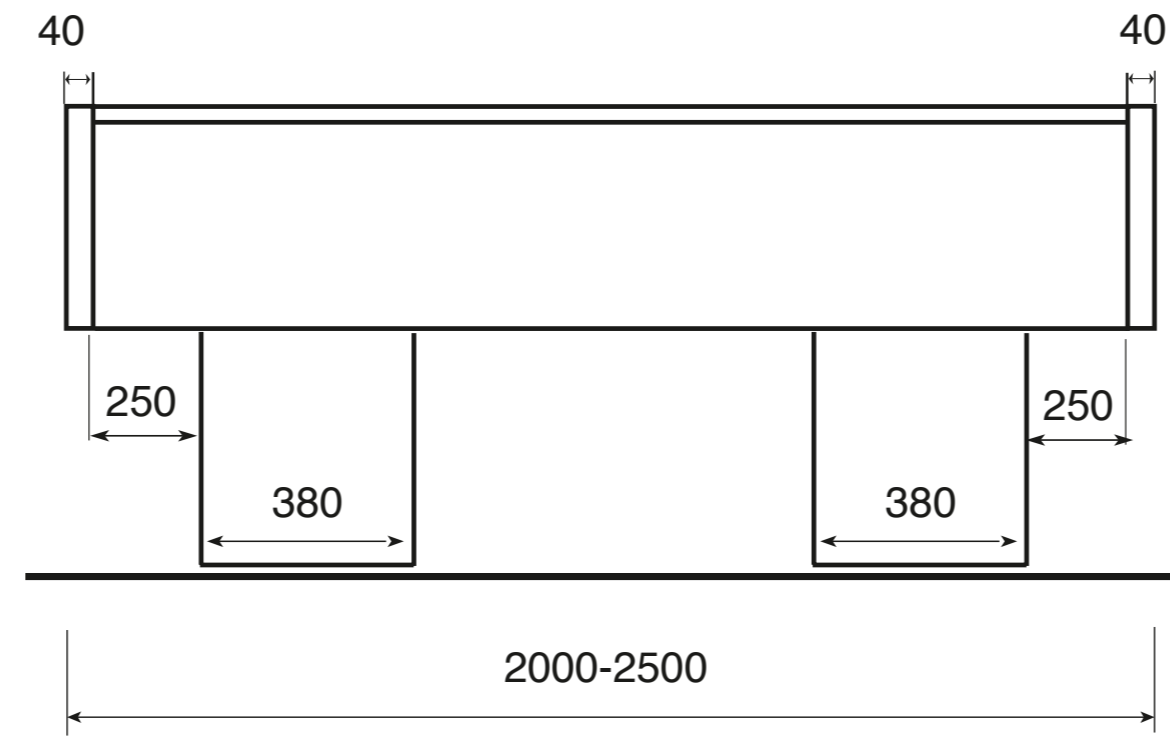
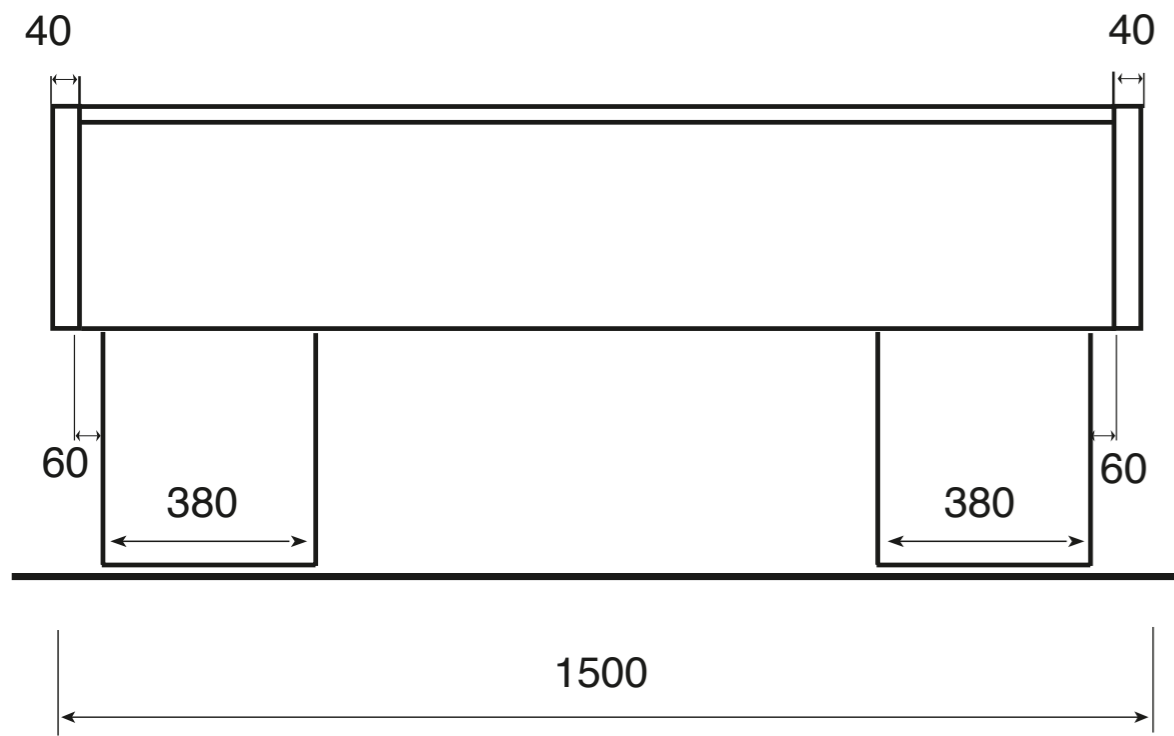

A= SCARICO - OUTLET - ABLAUF - DECHARGE.

B= TUBI UNITA' - PIPES REFR. UNIT - ROEHREN KUEHLAGGREGAT - TUBES GROUPE REFR.

I dati tecnici possono essere soggetti a cambiamenti senza alcun obbligo di preavviso. We reserve the right to change technical features without notice. Technische aenderungen sind ohne voranzeige moeglich. Nous nous reservons le droit de varier sans preavis les details techniques.

Modello: SG	Revisione: 00
Codice: SG	Data: 27-08-2018